

SONY[®]

Counter Unit

LH51-2T02 / -3T07

Read all the instructions in the manual carefully before use and strictly follow them.
Keep the manual for future references.

Magnescape[®]

Instruction Manual

	For 100 to 120 V	For 220 to 240 V
Plug Cap	Parallel blade with ground pin (NEMA 5-15P Configuration)	None
Cord	Type SVT or SJT, Three 16 or 18 AWG wires	Type SVT or SJT, Three 16 or 18 AWG wires
Length	Maximum 15 feet	Maximum 15 feet
Rating	Minimum 10 A, 125 V	Minimum 10 A, 250 V

Safety Precautions

Sony Manufacturing Systems Corporation products are designed in full consideration of safety. However, improper handling during operation or installation is dangerous and may lead to fire, electric shock or other accidents resulting in serious injury or death. In addition, these actions may also worsen machine performance.

Therefore, be sure to observe the following safety precautions in order to prevent these types of accidents, and to read these "Safety Precautions" before operating, installing, maintaining, inspecting, repairing or otherwise working on this unit.

Warning indication meanings

The following indications are used throughout this manual, and their contents should be understood before reading the text.

Warning

Failure to observe these precautions may lead to fire, electric shock or other accidents resulting in serious injury or death.

Caution

Failure to observe these precautions may lead to electric shock or other accidents resulting in injury or damage to surrounding objects.

Note

This indicates precautions which should be observed to ensure proper handling of the equipment.

Warning



- Do not use the counter unit with voltages other than the indicated power voltage, and do not connect multiple plugs to a single outlet as this may result in fire or electric shock.
- Do not damage, modify, excessively bend, pull on, place heavy objects on or heat the power cord, as this may damage the power cord and result in fire or electric shock.
- Do not handle the power plug with wet hands as this may result in electric shock.
- Do not open the cover of the counter unit to disassemble or modify the unit or to replace the fuses, as this may result in burns or injury. These actions may also damage the internal circuitry.

Operating Cautions

* Be sure to observe the following cautions.

- Use the supplied power cord.

Warning

The POWER cord contains a safety earth ground. Make sure to connect this earth ground. Failure to do so may result in electric shock or fire.

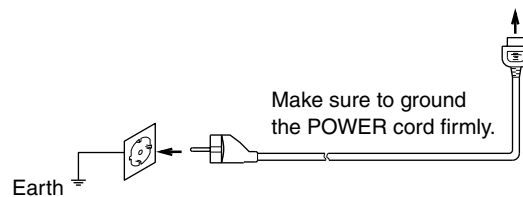

Caution

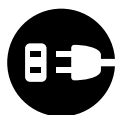

- When unplugging the power plug, do not pull on the power cord as this may damage the cord and result in fire or electrical shock. Be sure to grip the power plug when unplugging it from the socket.
- The unit does not have an explosion-proof structure. Therefore, do not use the unit in an atmosphere charged with inflammable gases as this may result in fire.
- When the unit will not be used for an extended period of time, be sure to unplug the power plug from the socket for safety.
- Be sure to turn off the power before connecting or disconnecting power and signal connectors in order to prevent damage or misoperation.
- The unit does not have an earthquake-proof structure. Therefore, do not use the unit in moving areas or areas exposed to strong shocks.

Contents

1. Preface	2	5-8. Multiple Datum Point Function	50
1-1. General Precautions	2	5-8-1. Setting the multiple datum point offset value (input while counting)	50
1-2. Handling Instructions	3	5-8-2. Checking the multiple datum point numbers in use	51
2. Features	4	5-8-3. Editing the multiple datum point offset values (input in edit mode)	51
3. Installation	5	5-8-4. Checking the datum point offset values	52
3-1. Connection of Cables	5	6. Linear Compensation	53
3-2. Mounting of Counter Unit	7	6-1. Setting Linear Compensation	53
4. Name and Function of Each Part	8	6-2. Measuring Linear Compensation Amount	55
4-1. Front Panel	8	7. Remote Reset Input Connector	58
4-2. Flat Keyboard	9	8. Alarm Display	60
4-3. Current Position Display and Operating Mode Indicators	10	9. Troubleshooting	61
5. Operation	11	10. Specifications	62
5-1. Initial Settings	11	11. Dimensions	64
5-1-1. Setting the input resolution and polarity	13		
5-1-2. Setting the display resolution	14		
5-1-3. Setting the linear compensation	16		
5-1-4. Setting the scaling	17		
5-1-5. Setting the distance from the absolute zero point of the scale to the cutting datum point	18		
5-1-6. Absolute zero point clear control	19		
5-1-7. Setting of touch sensor radius	20		
5-1-8. Setting the energy-saving mode	21		
5-1-9. Setting inch/mm switching	22		
5-2. Applying Power and Resetting	23		
5-3. Key Operations	24		
5-4. Correcting Erroneous Operations	26		
5-5. Data Storage	27		
5-6. Basic Operations	28		
5-6-1. Presetting	28		
5-6-2. Recalling preset data	29		
5-6-3. Datum point setting and display mode selection	29		
5-6-4. Mid-point calculation	31		
5-7. Applied Operations	32		
5-7-1. Bolt hole circle and simple R cutting functions (2 or 3 axes display only)	32		
5-7-2. Touch sensor (option)	38		
5-7-3. Detecting function of absolute zero point of scale	44		
5-7-4. Offset zero point	47		

1. Preface

Read all instructions carefully before use.

The LH51-2T02/-3T07 counter unit will benefit you with reduced machining time and higher machining accuracy.

To make full use of the unit's functions, read this instruction manual through carefully, and keep it properly for future references.

1-1. General Precautions

When using Sony Manufacturing Systems Corporation products, observe the following general precautions along with those given specifically in this manual to ensure proper use of the products.

- Before and during operations, be sure to check that our products function properly.
- Provide adequate safety measures to prevent damage in case our products should develop a malfunction.
- Use outside indicated specifications or purposes and modification of our products will void any warranty of the functions and performance as specified for our products.
- When using our products in combination with other equipment, the functions and performance as noted in this manual may not be attained, depending upon the operating environmental conditions. Make a thorough study of the compatibility in advance.

1-2. Handling Instructions

- Do not route the head connecting cable, power cord, etc. together with the machine power line in one duct.
- Supply power from an AC lamp source.
- Connect the ground terminal to the machine with the supplied ground wire. Make sure the machine is grounded.

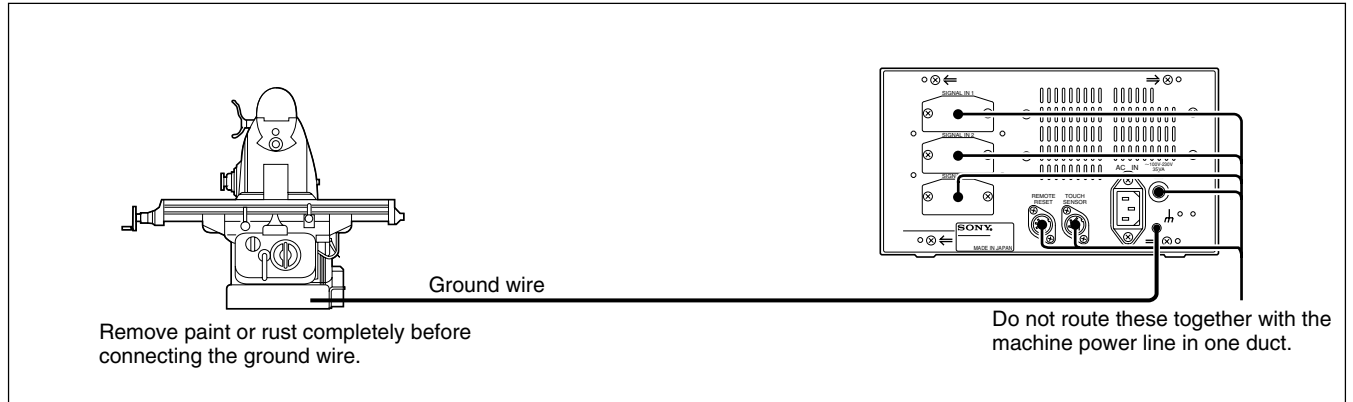

- Place the counter unit more than 0.5 m (20") away from a high voltage source, large current source, large power relay, etc.
- For installation of the counter unit, avoid a location exposed to chips, cutting oil, or machine oil. If unavoidable, take adequate countermeasures.
- Do not put a vinyl cover directly over the counter unit or put it in a closed container.
- The ambient temperature should be in the range of 0 to 40°C (32 to 104°F). Avoid exposure to direct sunlight, hot air currents, or heated air.

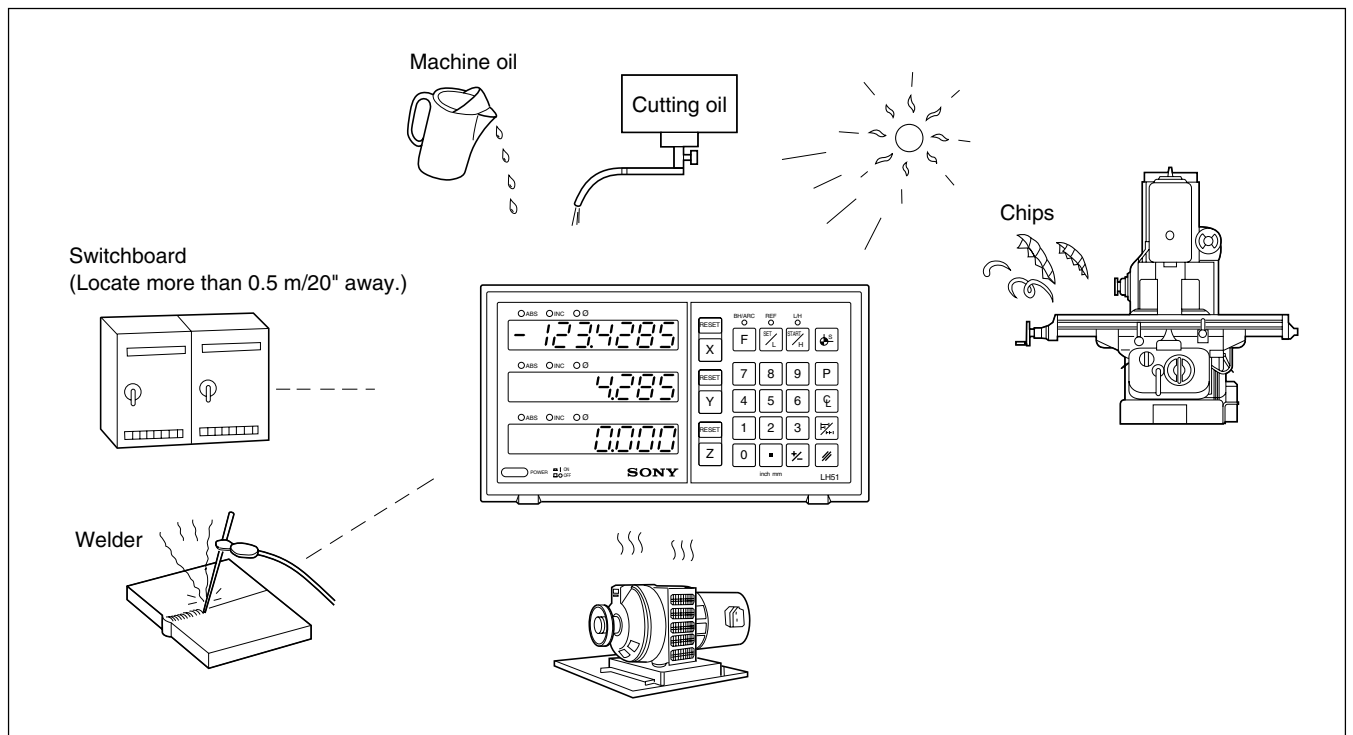

- If the power supply voltage is lower than specified, the display may not be illuminated even with the power switch turned on.
Be sure to use the power in the specified range.
- Note that if the power is interrupted momentarily or the voltage drops temporarily below the normal operating range, an alarm may operate or a malfunction may occur.
- Be sure to use the counter unit inside.

2. Features

Selectable display resolution

The display resolution can be selected from the following according to the connected scale.

Magnescale axes	: 0.0005 mm, 0.001 mm, 0.005 mm, 0.01 mm and diameter display (0.00002", 0.00005", 0.0001", 0.0005" and diameter display)
GA axes	: 0.005 mm, 0.01 mm and diameter display (0.0002", 0.0005", 0.001" and diameter display)
Digiruler axes	: 0.01 mm, 0.02 mm, 0.05 mm, 0.1 mm and diameter display (0.0005", 0.001", 0.002", 0.005" and diameter display)

Machine error compensation

The LH51-2T02/-3T07 compensates errors arising from the inclination or deflection of a machine tool, and displays the actual displacement of the machine. Thus, the displayed value accords with the actual displacement of a workpiece to achieve high-accuracy positioning and machining and restoration of machine tool accuracy.

Data storage function

Data on display and preset data are held automatically.
Therefore, data is retained even after power is turned off or in case of a temporary power outage.

Bolt hole circle function (2 or 3 axes display only)

Bolt hole positions are calculated and displayed by inputting the center point, diameter and number of holes.

Simple R cutting function (2 or 3 axes display only)

The arc cutting positions are calculated and displayed by inputting the center point and radius of the arc, the tool bore, feed angle and other data.

Touch sensor

The Touch sensor (option) facilitates the setting of a datum point and the measurement of a workpiece.

3. Installation

3-1. Connection of Cables

Fasten the connecting cables to stationary members to prevent accidental disconnection. Be sure to turn off the power of the counter unit before connecting or disconnecting the connector.

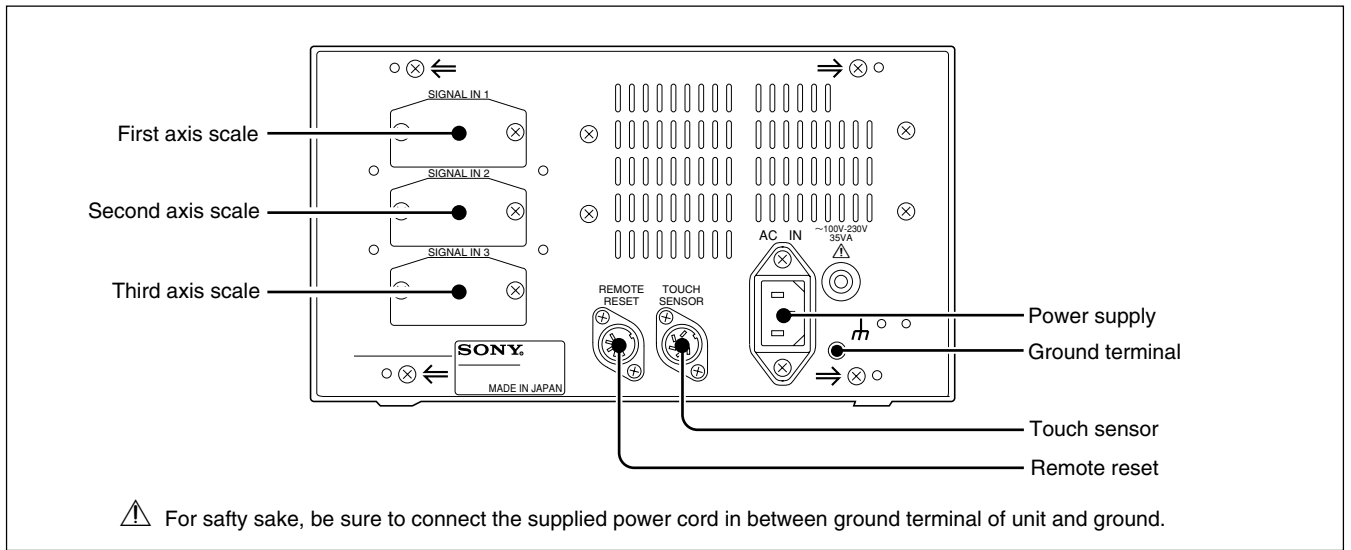

Example: Connection of LH51-2T02/3T07

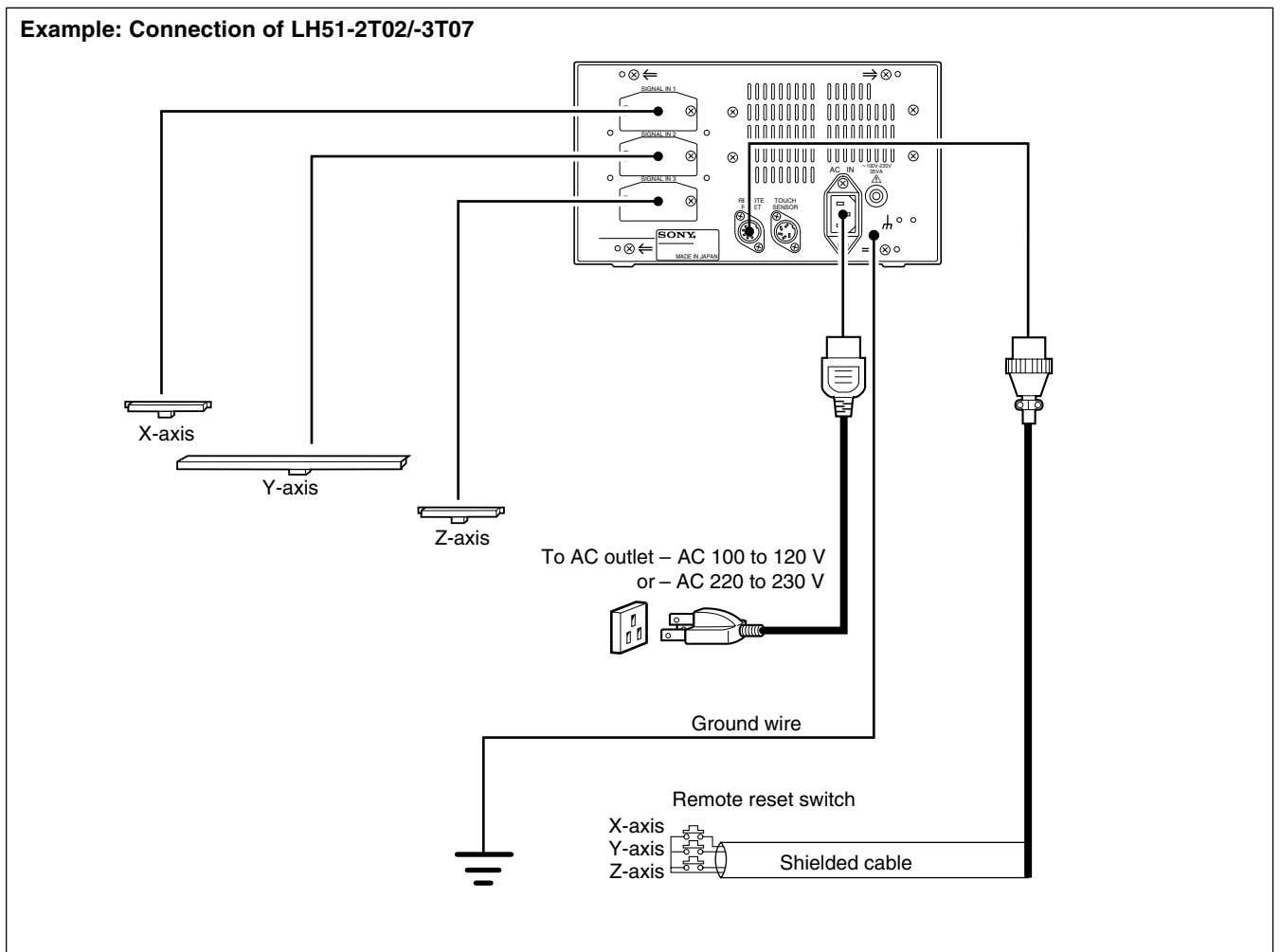

Note

Be sure to put the supplied dust cap on unused connector.

Connection precautions

These are precautions for connecting the scale to the counter unit.

Procedure of connecting the cable

Since a precision connector is used for this unit, please be careful connect to the counter unit in a gentle way following the order described below.

- 1** Remove the two screws securing the joint cover on the back side of the counter unit and then remove the cover.

Note

The two screws (special-purpose screws) that are removed in this step are used for securing the adaptor mounting plate. Therefore, be careful not to lose these screws.

- 2** Insert the adaptor of the cable gently to the joint of the counter unit.
(There is approximately 1 mm / 0.039" clearance between the mounting plate and the backside of the counter unit.)

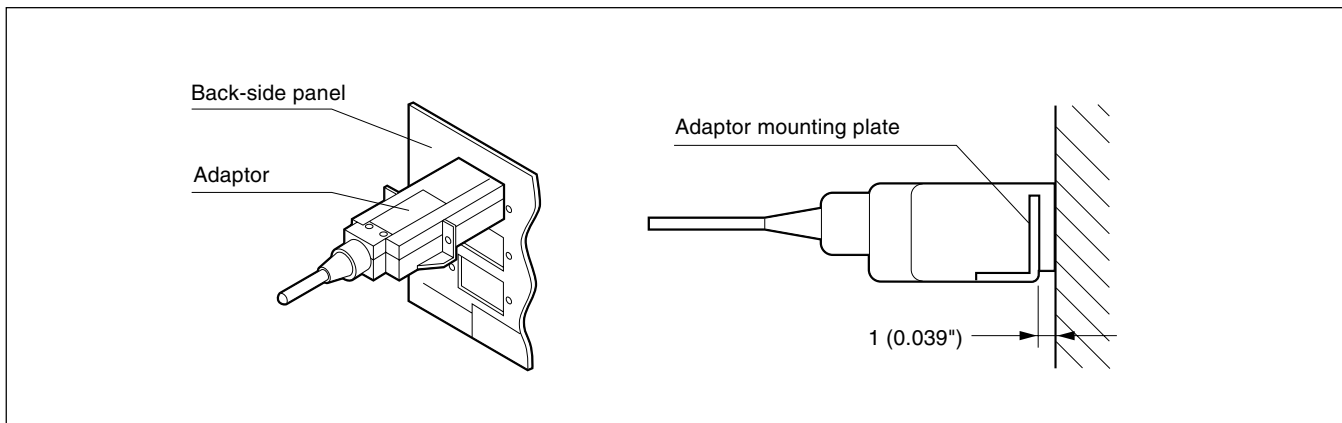

- 3** Push the connector (approximately 1 mm / 0.039") until the mounting plate touches the back-side panel of the counter unit.

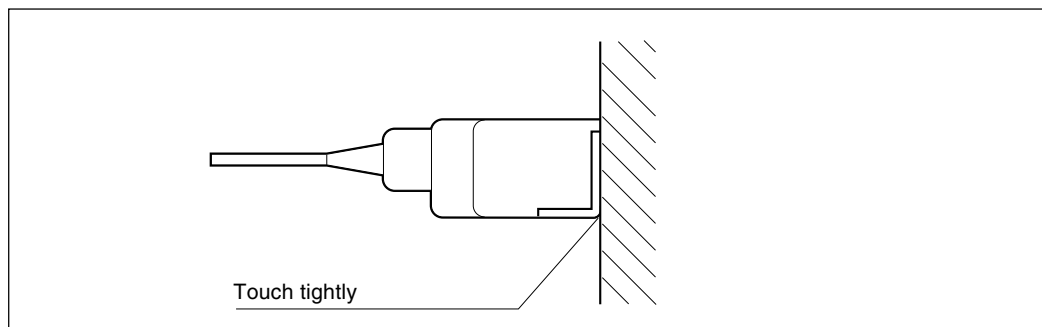

4 Fix the mounting plate using the screws removed in step "1" above.

Note

The screws used for securing the adapter mounting plate are special-purpose screws*. Do not use any other types of screws. Usage of other screws can result in the wrong count and error messages.

* Screw type: +PSW3 × 6 (washer is a small, round type)

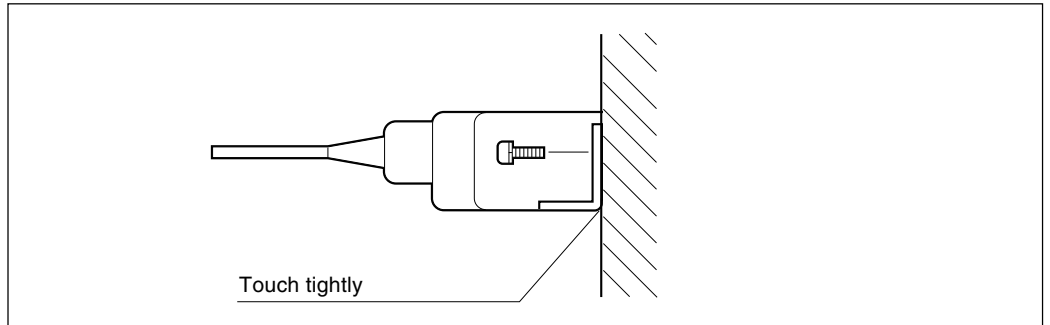

5 Turn on the power of the counter unit and make sure if it operates normally.

3-2. Mounting of Counter Unit

Use the accessory brackets and screws for mounting the counter unit.

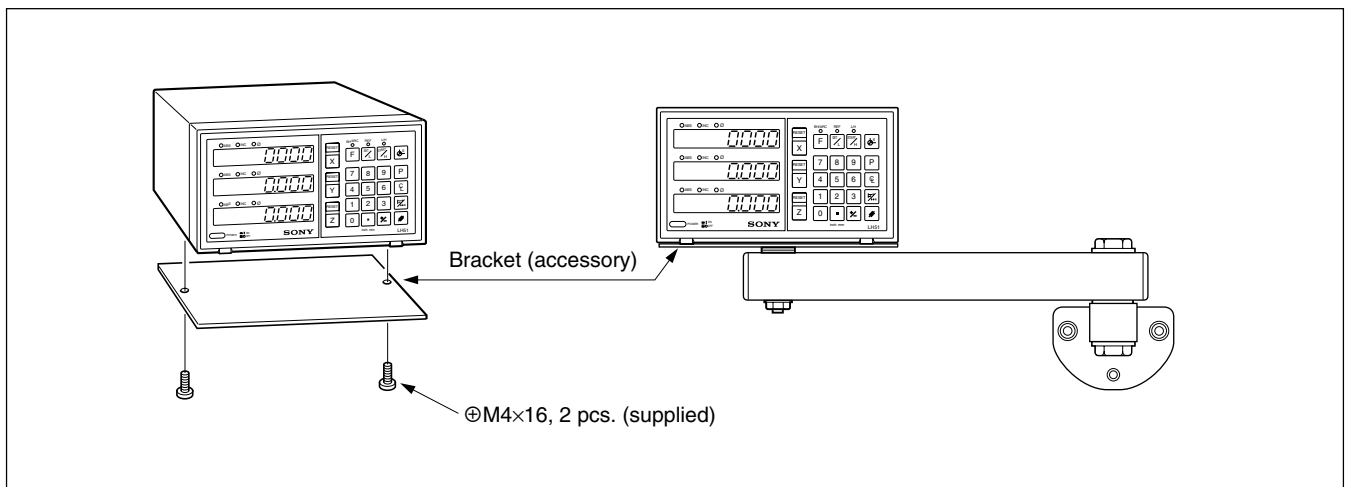

Note

Be sure to use the supplied screws. Use of oversized screws may damage the internal circuitry.

4. Name and Function of Each Part

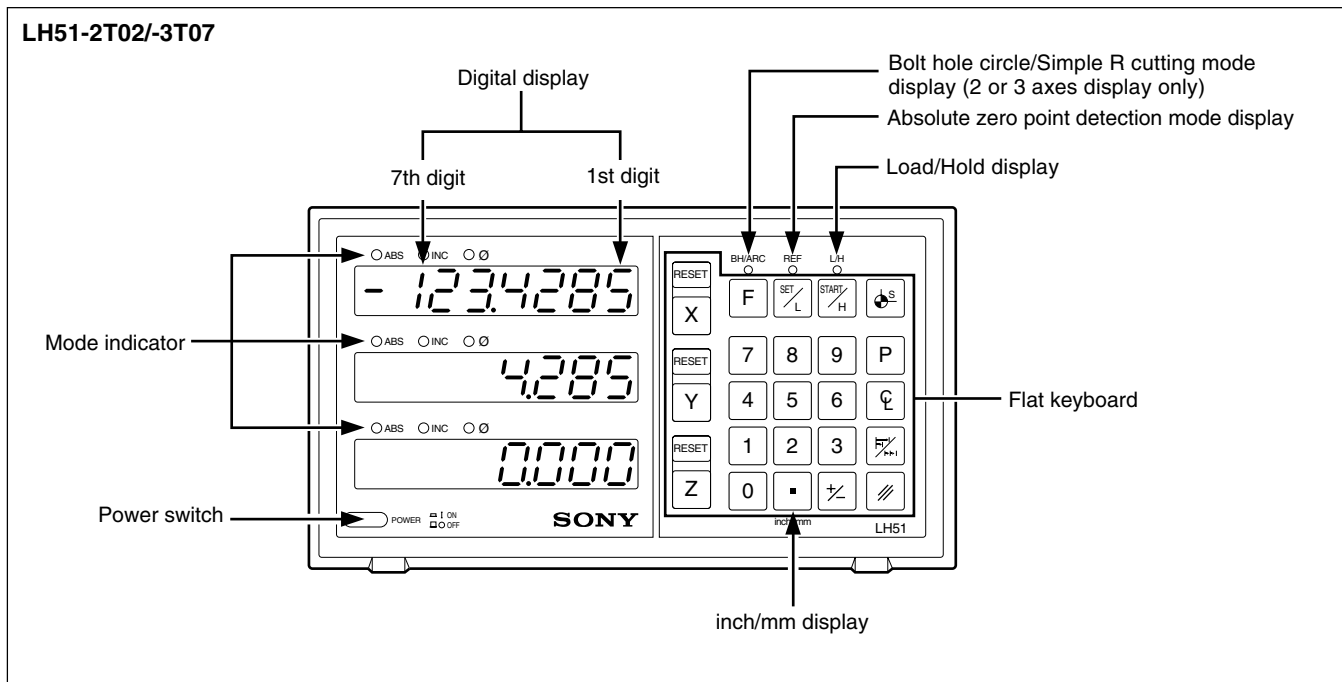

4-1. Front Panel









Name of part	Function
Power Switch	Press it to turn on the power, and "SONY" will be displayed. To turn off the power, depress it again.

4-2. Flat Keyboard





Reset and cancel keys

Name of part	Function
 RESET Reset key	Resets displayed value to zero.
 Cancel key	<ol style="list-style-type: none"> 1. Cancels a value set on the axis. 2. Releases the hold value to display the current value.



Designation of operation axis and presetting of values

Name of part	Function
 X Y Z Axis selector key	Select an axis to give a command for the selected axis.
 0 ~ 9  Number keys	Sets desired values and a decimal point.
 Polarity selector key	Sets a value of minus polarity. Press this key before setting a numeric value.
 P Preset key	Displays a preset value. If a new value is not input, the previous preset data is displayed.
 Display mode selector key	Switches between ABS and INC displays.

Establishment of datum point

Name of part	Function
 1/2 key	<ol style="list-style-type: none"> 1. Halves the displayed value in the INC mode. 2. Touch sensor hold display is canceled, and the present position from the center of the workpiece is displayed.
 Datum point setting key	Establishes a datum point.
 F Function key	Used to select the Bolt hole circle/Simple R cutting mode or the Absolute zero point detection mode. When this key is pressed, the mode is switched in the order of the Bolt hole circle/Simple R cutting mode, Absolute zero point detection mode, and Touch sensor mode.
 Function setting key/ LOAD key	<ol style="list-style-type: none"> 1. Used to start the counting when the Touch sensor touches the datum plane or passes the absolute zero point of the scale. 2. Used to make the various settings in the Bolt hole circle/Simple R cutting mode. 3. Used to set the multiple datum point numbers and save the values.
 Execute key/HOLD key	<ol style="list-style-type: none"> 1. Used to hold the value displayed the moment the Touch sensor touches the datum plane or passes the absolute zero point of the scale. 2. Used to store the hold display value in the memory or to release the hold display to display the current value in the Absolute zero point detection mode. 3. Used to start the processing in the Bolt hole circle/Simple R cutting mode. 4. Used to enter the multiple datum point numbers.

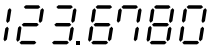
4-3. Current Position Display and Operating Mode Indicators

Name of part	Function
 inch/mm selector key	Press it to select English (in inches) or metric (in millimeters) display.
 Digital display	Displays for each axis a positive or negative value of 7 digits with unnecessary leading zeros blanked out. An alarm is also displayed in case of trouble.
Mode indicators	<p>ABS Indicates the absolute mode is set. (When multiple datum points are used, the indicator flashes instead of turning on.) The distance from the spot position to the datum point initially set is displayed. ABS is indicated also when a datum point is established.</p> <p>INC Indicates the incremental mode is set. (When multiple datum points are used, the indicator flashes instead of turning on.) In this mode, incremental positioning is made with  keys and preset key .</p> <p>∅ Indicates that the resolution is set to diameter display mode.</p>

5. Operation

Cautions on Operation

- 1) When a malfunction occurs, characters as shown in “8. Alarm Display” on page 60 are displayed in place of numerals. When the alarm display appears, press the **RESET** key for the relevant axis and repeat the operation.
- 2) If two or more operation keys are pressed simultaneously, a malfunction may be caused.
- 3) Make sure that the least significant digit of an entered value agrees with the selected resolution.

5-1. Initial Settings

Before starting the operation, make the following initial settings:

Initial setting item
5-1-1. Setting the input resolution and polarity
5-1-2. Setting the display resolution
5-1-3. Setting the linear compensation
5-1-4. Setting the scaling
5-1-5. Setting the distance from the absolute zero point of the scale to the cutting datum point
5-1-6. Absolute zero point clear control
5-1-7. Setting of touch sensor radius
5-1-8. Setting the energy-saving mode
5-1-9. Setting inch/mm switching

- Skip unnecessary initial settings by pressing an Axis selector key, and proceed to the next setting. After all the initial settings are completed, press the **RESET** key. The value that was displayed before the power was turned off is displayed, and the unit is switched to the measurement mode.
- By pressing the **RESET** key at any time during initial setting, the value that was displayed before the power was turned off is displayed, and the unit is switched to the measurement mode.
- The initial settings, once made, are stored even if the power is turned off. Therefore the initial settings are necessary only when the system is newly installed or when any setting revision is required.

- The axis selector keys and corresponding axes are as follows when making the initial settings.

Connected scales	Axis	Axis Selector Key	Display
Connector 1 axis	X-axis	X	1Cr.1r.1Lr
Connector 2 axes	Y-axis	Y	2Cr.2r.2Lr
Connector 3 axes	Z-axis	Z	3Cr.3r.3Lr

To set them initial setting mode

Hold down the X-axis  key and turn the power switch ON.

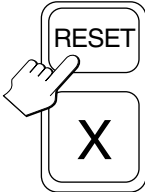
1  Hold down

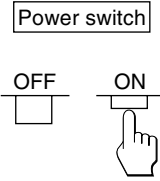
2  Power switch OFF ON

The resolution set for each axis will be displayed.

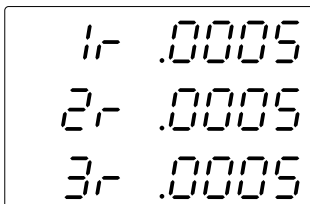

Unless otherwise specified, the following descriptions apply to all axes. Therefore, only the settings for the X-axis are described. Set the Y-axis and Z-axis in the same manner. Set the second and third axes in the same manner.

Note

When the type of scale axis changes, this mode is forcibly selected without pressing an axis selector key.

5-1-1. Setting the input resolution and polarity

- Select the input resolution and polarity setting mode by pressing the X-axis selector key when the display is as shown in 5-1.
 - The minus “-” display indicates that the polarity is inverted.
 - The input resolution and polarity can be set and changed with the key or key.
 - The resolution is automatically set for Magnescale, GA and Digiruler axes. Therefore, check that the following resolution is set automatically, and then only make the setting for the polarity.
 - For Magnescale axes : the scale resolution is automatically set to 0.0005 mm
 - For GA axes : the scale resolution is automatically set to 0.005 mm
 - For Digiruler axes : the scale resolution is automatically set to 0.01 mm
- If the scale is not automatically set to the resolution shown above, redo the setting by following the procedure in “3-1. Connection of Cables”.

Example : X-axis (Magnescale axis)

Operating Procedure		Display
<input type="button" value="X"/>	Select the X-axis. The scale resolution is automatically set to 0.0005 mm.	10.0005
<input type="button" value="0"/>	Press the <input type="button" value="0"/> key to increase the value.	- 10.0005



- When connecting other scales using the DZ51/SZ51-AB01 or similar devices, the resolution can be selected from 0.0001 mm, 0.0005 mm, 0.001 mm, 0.005 mm, 0.01 mm, 0.025 mm, 0.05 mm and 0.1 mm.
Set the resolution to match that of the connected scale.

Display	Resolution
.0001	0.0001 mm
.0005	0.0005 mm
.001	0.001 mm
.005	0.005 mm
.01	0.01 mm
.025	0.025 mm
.05	0.05 mm
.1	0.1 mm

5-1-2. Setting the display resolution

- Select the Resolution setting mode by pressing the X-axis selector key when the display is as shown in 5-1-1.
- The resolution can be set and changed with the $\square 0$ key or $\square \pm$ key.

Example : X-axis

Operating Procedure		Display
	Select the X-axis.	1. .0005
	Press the $\square 0$ key to increase the value.	1. .0005 (ø lights)
	Press this key to decrease the value.	1. .01 (ø lights)

• Magnescale axis

Display (mm lamp lights)	Resolution	Display (inch lamp lights)	Resolution
.0005	0.0005 mm	.00002	0.00002 in
.0005 (ø lights up)	ø	.00002 (ø lights up)	ø
.001	0.001 mm	.00005	0.00005 in
.001 (ø lights up)	ø	.00005 (ø lights up)	ø
.005	0.005 mm	.0001	0.0001 in
.005 (ø lights up)	ø	.0001 (ø lights up)	ø
.01	0.01 mm	.0005	0.0005 in
.01 (ø lights up)	ø	.0005 (ø lights up)	ø

• Degiruler axis

Display (mm lamp lights)	Resolution	Display (inch lamp lights)	Resolution
.01	0.01 mm	.0005	0.0005 in
.01 (ø lights up)	ø	.0005 (ø lights up)	ø
.02	0.02 mm	.001	0.001 in
.02 (ø lights up)	ø	.001 (ø lights up)	ø
.05	0.05 mm	.002	0.002 in
.05 (ø lights up)	ø	.002 (ø lights up)	ø
.1	0.1 mm	.005	0.005 in
.1 (ø lights up)	ø	.005 (ø lights up)	ø

• GA axis

Display (mm lamp lights)	Resolution	Display (inch lamp lights)	Resolution
.005	0.005 mm	.0002	0.0002 in
.005 (ø lights up)	ø	.0002 (ø lights up)	ø
.01	0.01 mm	.0005	0.0005 in
.01 (ø lights up)	ø	.0005 (ø lights up)	ø
		.001	0.001 in
		.001 (ø lights up)	ø

• Other scales axes

Display (mm lamp lights)	Resolution	Display (inch lamp lights)	Resolution
.0001	0.0001 mm	.5E-6	0.000005 in
.0001 (ø lights up)	ø	.5E-6 (ø lights up)	ø
.0005	0.0005 mm	.00002	0.00002 in
.0005 (ø lights up)	ø	.00002 (ø lights up)	ø
.001	0.001 mm	.00005	0.00005 in
.001 (ø lights up)	ø	.00005 (ø lights up)	ø
.002	0.002 mm	.0001	0.0001 in
.002 (ø lights up)	ø	.0001 (ø lights up)	ø
.005	0.005 mm	.0002	0.0002 in
.005 (ø lights up)	ø	.0002 (ø lights up)	ø
.01	0.01 mm	.0005	0.0005 in
.01 (ø lights up)	ø	.0005 (ø lights up)	ø
.02	0.02 mm	.001	0.001 in
.02 (ø lights up)	ø	.001 (ø lights up)	ø
.025	0.025 mm	.002	0.002 in
.025 (ø lights up)	ø	.002 (ø lights up)	ø
.05	0.05 mm	.005	0.005 in
.05 (ø lights up)	ø	.005 (ø lights up)	ø
.1	0.1 mm		
.1 (ø lights up)	ø		

Note

- Press the key to select English (inches) or metric (millimeters) display.
- ø : Diameter display (double counting)
The decimal point remains at the same position.
- The display resolution of the counter unit cannot be set higher than the input resolution of the scale input to the counter unit.
Example: When inputting a scale with an input resolution of 0.001 mm to the counter unit, the display resolution can be set to 0.001 mm, 0.002 mm, and so on, up to 0.1 mm.

5-1-3. Setting the linear compensation

- After completing 5-1-2, press the Axis selector key for the Linear compensation setting mode.
- Number keys and **[P]** key are used to choose one of the linear compensation amounts below. The lower 3 digits of the compensation amount to be set are displayed.
- Select the linear compensation amount per meter as shown below.
256 different linear compensations (per meter) are available for selection: ± 0.001 mm, ± 0.002 mm, ± 0.003 mm, ± 0.004 mm, ± 0.005 mm, ± 0.006 mm, ± 0.007 mm, ± 0.008 mm, ± 0.009 mm, ± 0.010 mm, ± 0.015 mm (in 0.005 mm steps) up to ± 0.600 mm
- For details, refer to “6. Linear Compensation”.
The unit is delivered without compensation set “LC 000”.

Example : X-axis

Operating Procedure	Display
Example: To set the compensation amount for the X-axis to -0.015 mm <div style="display: flex; align-items: center; margin-bottom: 10px;"> <div style="border: 1px solid black; padding: 5px; margin-right: 10px; text-align: center; width: 40px; height: 40px; display: flex; align-items: center; justify-content: center; font-size: 24px;">X</div> <div style="margin-left: 10px;">Select the X-axis.</div> </div>	<div style="font-family: monospace; font-size: 24px; letter-spacing: 0.5em;">1 L C 0 0 0</div>
<div style="display: flex; align-items: center; margin-bottom: 10px;"> <div style="border: 1px solid black; padding: 5px; margin-right: 5px; text-align: center; width: 40px; height: 40px; display: flex; align-items: center; justify-content: center; font-size: 24px;">0</div> <div style="border: 1px solid black; padding: 5px; margin-right: 5px; text-align: center; width: 40px; height: 40px; display: flex; align-items: center; justify-content: center; font-size: 24px;">1</div> <div style="border: 1px solid black; padding: 5px; margin-right: 10px; text-align: center; width: 40px; height: 40px; display: flex; align-items: center; justify-content: center; font-size: 24px;">5</div> <div style="margin-left: 10px;">Press the number keys.*</div> </div>	<div style="font-family: monospace; font-size: 24px; letter-spacing: 0.5em;">1 L C 0 1 5</div>
<div style="display: flex; align-items: center; margin-bottom: 10px;"> <div style="border: 1px solid black; padding: 5px; margin-right: 10px; text-align: center; width: 40px; height: 40px; display: flex; align-items: center; justify-content: center; font-size: 24px;">±/−</div> <div style="margin-left: 10px;">Press the [±/−] key.</div> </div>	<div style="font-family: monospace; font-size: 24px; letter-spacing: 0.5em;">1 L C - 0 1 5</div>
<div style="display: flex; align-items: center; margin-bottom: 10px;"> <div style="border: 1px solid black; padding: 5px; margin-right: 10px; text-align: center; width: 40px; height: 40px; display: flex; align-items: center; justify-content: center; font-size: 24px;">P</div> <div style="margin-left: 10px;">Press the Preset key to complete the setting.</div> </div>	<div style="font-family: monospace; font-size: 24px; letter-spacing: 0.5em;">1 L C - 0 1 5</div>

* The setting cannot be performed if a number key other than those specified for the linear compensation is pressed.

5-1-4. Setting the scaling

- After completing the operation in 5-1-3, press the Axis selector key again to select the setting mode for the scaling.
- Use the number keys and **[P]** key to set and change the scaling.
- The scaling is set at the factory to 1.000000.

Example : X-axis

Operating Procedure	Display
<div style="display: flex; align-items: center; gap: 20px;"> <div style="border: 1px solid black; padding: 5px; width: 40px; text-align: center; font-size: 24px;">X</div> <div> <p>Select the X-axis.</p> </div> </div>	<p style="text-align: center; font-family: monospace; font-size: 24px;">SCALING</p> <p style="text-align: center; font-size: 12px;">(Displayed for approx. 1 second)</p>
<div style="display: flex; align-items: center; gap: 20px;"> <div style="border: 1px solid black; padding: 5px; width: 40px; text-align: center; font-size: 24px;">0</div> <div style="border: 1px solid black; padding: 5px; width: 20px; text-align: center; font-size: 24px;">▪</div> <div style="border: 1px solid black; padding: 5px; width: 40px; text-align: center; font-size: 24px;">5</div> <div> <p>Press the number keys.</p> </div> </div>	<p style="text-align: center;">↓</p> <p style="text-align: center; font-family: monospace; font-size: 24px;">1.000000</p>
<div style="display: flex; align-items: center; gap: 20px;"> <div style="border: 1px solid black; padding: 5px; width: 40px; text-align: center; font-size: 24px;">P</div> <div> <p>Press the Preset key to complete the setting.</p> </div> </div>	<p style="text-align: center; font-family: monospace; font-size: 24px;">0.5</p> <p style="text-align: center; font-family: monospace; font-size: 24px;">0.500000</p>

Note

- When the scaling function is used, a reduction or magnification count of any ratio can be performed with respect to the actual movement distance. This compensates contraction of the resin during mold manufacture, etc., enabling the product dimensions to be converted to the mold dimensions.











A setting of 0.100000 to 9.999999 can be made for each axis.

Display value = actual movement distance × n (n = scaling value)

5-1-5. Setting the distance from the absolute zero point of the scale to the cutting datum point

- After completing 5-1-4, press the axis selector key to select the mode for setting the distance from the absolute zero point of the scale to a datum point.
- Number keys and the **P** key are used to set and change the distance from the absolute zero point to a datum point.
- If the LH51-2T02/-3T07 counter unit is used to replace another counter unit, and you have already made a note of the distance, the distance can be set by following the procedure below.
- The distance is factory set to 0.0000 mm.

Example : X-axis





Operating Procedure	Display
<p>Example: To set the distance to 10 mm</p> <p> Select the X-axis.</p> <p>  Press the number keys.</p> <p> Press the Preset key to complete the setting.</p>	<p>ABS, INC lights up   Lights up</p> <p>ABS, INC lights up   Flashes</p> <p>ABS, INC turns off   Lights up</p>

Note

- If the distance from the absolute zero point of the scale to the datum point has not been measured, this initial setting is not necessary as the distance will be automatically stored by performing the operations outlined in “Setting of datum point” (page 45).
- Numbers that can be input vary according to the resolution.
Example: In the case of 0.0005 mm: -999.9995 to +999.9995
 In the case of 0.01 mm: -99999.99 to +99999.99
 If the resolution is made finer after a large value is input with a coarse resolution, an overflow alarm display will result for the offset value ΔY .
- The ABS and INC indicator lights and REF flashes during number input. When the Preset key is pressed to confirm the number, the ABS and INC indicator turns off and REF lights steadily.

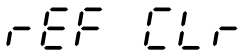
5-1-6. Absolute zero point clear control

- This control becomes necessary when the scale with built-in absolute zero point is replaced or reinstalled. This control is usually not necessary when using the unit for the first time.
- When the scale with built-in absolute zero point is replaced, be sure to perform the following controls in the setting mode as described in 5-1-5.

Operating Procedure	Display
<div style="display: flex; align-items: center; justify-content: center; margin-bottom: 20px;">  <div style="margin-left: 20px;">Press the Cancel key.</div> </div> <div style="display: flex; align-items: center; justify-content: center;"> <div style="margin-right: 20px;">Setting completed.</div> </div>	<div style="text-align: center; margin-bottom: 20px;">  <p>(Displayed for approx. 2 seconds)</p> </div> <div style="text-align: center; margin-bottom: 20px;">  </div> <div style="text-align: center;">  </div> <div style="display: flex; justify-content: flex-end; align-items: center; margin-top: 10px;"> <div style="text-align: center; margin-right: 10px;">  Flashes </div> <div style="text-align: center; margin-right: 10px;">  Lights up </div> </div>

Note

REF flashes during absolute zero point clearance processing. When the processing ends, REF lights steadily.

5-1-7. Setting of touch sensor radius

- After completing 5-1-5, press the X-axis selector key for the Touch sensor radius setting mode.
- Number keys and **[P]** key are used to set and change the touch sensor radius.
- The touch sensor radius is factory set to 5.0000 mm.
- Correct setting of the touch sensor radius makes correct display of the reference point or measuring range possible in the load or hold operation with the touch sensor.
- In the example below, the resolution is set to 0.0005 mm.

Note

The touch sensor radius setting can only be made for the X-axis.

Example

Operating Procedure	Display
<p>Example: Setting the radius to 10 mm</p> <div style="display: flex; align-items: center; margin-bottom: 20px;"> <div style="border: 1px solid black; padding: 5px; margin-right: 10px; text-align: center; width: 40px; height: 40px; line-height: 40px;">X</div> <div style="margin-left: 10px;">Select the X-axis.</div> </div> <div style="display: flex; align-items: center; margin-bottom: 20px;"> <div style="border: 1px solid black; padding: 5px; margin-right: 10px; text-align: center; width: 40px; height: 40px; line-height: 40px;">1</div> <div style="border: 1px solid black; padding: 5px; margin-right: 10px; text-align: center; width: 40px; height: 40px; line-height: 40px;">0</div> <div style="margin-left: 10px;">Press the number keys.</div> </div> <div style="display: flex; align-items: center;"> <div style="border: 1px solid black; padding: 5px; margin-right: 10px; text-align: center; width: 40px; height: 40px; line-height: 40px;">P</div> <div>Press the Preset key to complete the setting.</div> </div>	<div style="text-align: center; margin-bottom: 10px;"> <p>7.5 rad</p> <p>(Displayed for approx. 1 second)</p> <p>↓</p> </div> <div style="text-align: center; margin-bottom: 10px;"> <p>5.0000</p> </div> <div style="text-align: center; margin-bottom: 10px;"> <p>10.</p> </div> <div style="text-align: center;"> <p>10.0000</p> </div>

5-1-8. Setting the energy-saving mode

- Select the energy-saving mode setting by pressing the X-axis selector key after completing the operations in 5-1-7.
- The time until activation of energy-saving mode can be set using the $\boxed{0}$ key and $\boxed{\pm}$ key.
- The default setting is OFF.

Note

The energy-saving mode setting is made for the X-axis only.

Example

Operating Procedure		Display
\boxed{X}	Select the X-axis.	ES OFF
$\boxed{0}$	Pressing the $\boxed{0}$ key adds the value.	ES 5
$\boxed{\pm}$	Pressing the $\boxed{\pm}$ key subtracts the value.	ES 60

Energy-saving mode time

Display	OFF	5	10	15	20	30	45	60
Setting time	None	5 minutes	10 minutes	15 minutes	20 minutes	30 minutes	45 minutes	1 hour



Note

- If the time set for energy-saving mode elapses with no scale movement or key operation, the display turns off and the underbar display “_ _” appears scrolling from left to right on the X-axis.
- Press any key to cancel energy-saving mode.
To cancel energy-saving mode, press any key or move the scale. The function of the key is not activated.

5-1-9. Setting inch/mm switching

- After completing 5-1-8, press the X-axis selector key to select the mode for setting whether or not inch/mm switching is performed.
- Inch/mm switching can be enabled or disabled with the $\boxed{0}$ key or $\boxed{\frac{1}{2}}$ key.
- Inch/mm switching is enabled exfactory.

Example

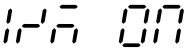
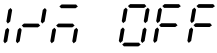
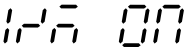
Operating Procedure	Display
<p style="text-align: center;">  </p> <p style="text-align: center;">Select the X-axis.</p> <p style="text-align: center;">  or  </p> <p style="text-align: center;">Press the $\boxed{0}$ or $\boxed{\frac{1}{2}}$ key.</p> <p style="text-align: center;">Pressing the $\boxed{0}$ or $\boxed{\frac{1}{2}}$ key again returns to the original display unit.</p>	<p style="text-align: center;">  (inch/mm switching enabled) </p> <p style="text-align: center;">  (inch/mm switching disabled) </p> <p style="text-align: center;">  (inch/mm switching enabled) </p>

5-2. Applying Power and Resetting

After installation, connections and setting of the resolution have been completed, begin machining as described in the procedure below.

1 Set the power switch to ON

Set the POWER switch to ON.

“5074” will be displayed.

If “5074” starts blinking or “Error” lights in the display, refer to “8. Alarm Display”.

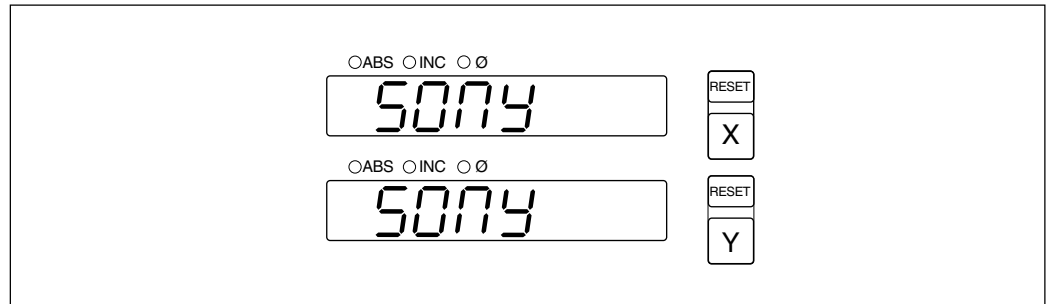

2 Press the RESET key.

The first time the  key of X- or Z-axis is pressed after the power is turned on, the previously displayed value (Incremental mode when the power is turned on) is displayed. After this, zero is displayed only for the reset axes. The unit is set to Incremental mode when reset.

However, if the power was turned off during bolt hole circle or simple R cutting execution, the value displayed when the  key is pressed is not the value displayed when the power was turned off.

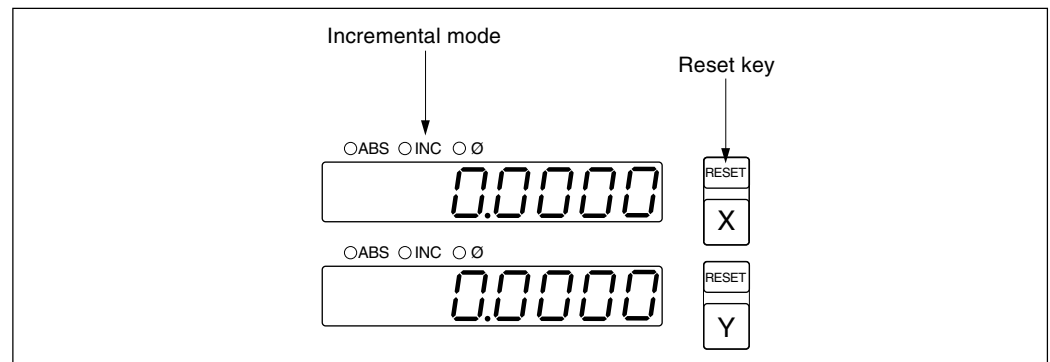

3 Start positioning.

When the machine table is moved, the displacement is displayed. The minus (–) sign appears depending on the direction of movement of the table.

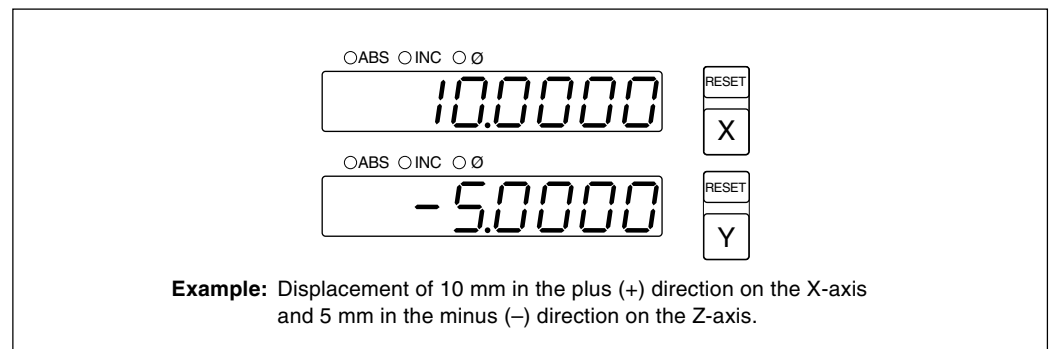

Note

In the example, the resolution is set to 0.0005 mm.













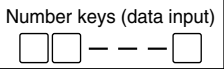

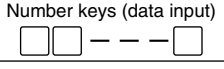
5-3. Key Operations

The LH51-2T02/-3T07 counter unit is basically operated with keys in the following sequence:
Axis key, data input, and Operation key.











Following is an example of the basic key operations on X-axes.

See the following pages for details. Operate the Y- and Z-axes in the same way.



• Basic key operations

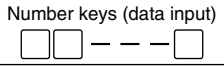

Start of operation	:	Turn on the power switch.	
Reset (zero display)	:		
Preset	:	  	
Setting of datum point	:	  	
Absolute/Incremental display selection :			
		 	Note If operations are performed directly without selecting the axis, all axes are switched simultaneously.
Recall	:	 	
Halving displayed values	:	 	
Cancel	:	 	
Inch/mm selector	:		



• Applied key operations

Touch Sensor (datum plane establishment):		
	 	→ [Touch the workpiece → Counting starts.]
Touch Sensor (distance measurement):		
	 	→ [Touch the workpiece → Display is held.]
	For centering the workpiece:	
Absolute zero point of scale (measurement from absolute zero point):		
	 	Press the  key twice to select the absolute zero point mode.
	  	[Absolute zero point passed → Counting starts.]



Absolute zero point of scale (measurement to absolute zero point):



  Press the  key twice to select the absolute zero point mode.

  → [Absolute zero point passed → Display is held.]



For storing the hold value into memory:  



Offset zero point



:   Press the  key twice to select the absolute zero point mode.

  → [Zero point passed → Counting starts.]

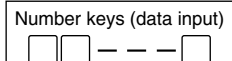
Bolt hole circle/Simple R cutting (2 or 3-axis display only):

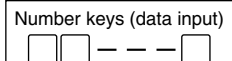

 Press the  key once to select the BH/ARC mode.

   (Enter the center point.)

 (Set the BH/ARC mode.)

Bolt hole circle

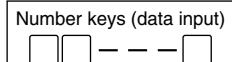

:    (Enter the diameter.)

  (Enter the number of divisions.)

  (Enter the starting angle.)

 (Execute.)

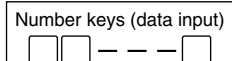
Simple R cutting

:    (Enter the radius.)

  (Enter the tool bore.)

  (Enter the starting angle.)

  (Enter the ending angle.)

  (Enter the feed angle.)

 (Execute.)

Changing the multiple datum point number:

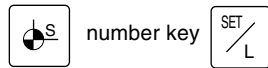



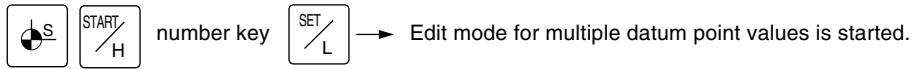

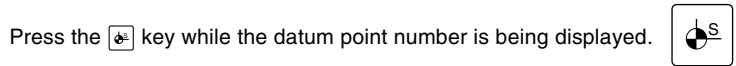

Editing the multiple datum point value:





Exiting edit mode:



5-4. Correcting Erroneous Operations

- 1) **When you have pressed the wrong axis selector key:**
 - To select the correct axis, press the correct axis selector key.
 - To clear the axis selection mode, press the cancel key .
- 2) **When you have pressed the wrong number key:**
 - Press the cancel key  and axis selector key before entering the correct numerals. If you have pressed the  or  key by mistake, press the axis selector key before entering the correct numerals.
- 3) **When LOAD key  or HOLD key  is pressed by mistake:**

Press the Axis selector key of the relevant axis  and the Cancel key , and repeat the entry.
- 4) **To cancel the hold:**

Press the Axis selector key of the held axis and the Cancel key  to return to the present value display.

5-5. Data Storage

When power is switched to OFF, the display value and preset data values are automatically held in memory. Because of this function, it is possible to interrupt operation and switch the power OFF or even sustain a sudden power outage without losing data. Restoring data is thus greatly simplified.

Interrupting the operation

1 Lock the machine.

Before interrupting the operation, be sure to lock the machine. Otherwise, correct restoration of the displayed value may be impossible.

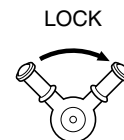

2 Set the power switch to OFF.

Data will be retained at the point the power is switched OFF.

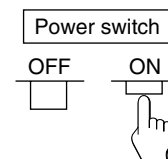

Note

If the machine table is moved after the power is switched OFF, the table movement is not tracked and when power is restored, the table position will not agree with the stored data which is displayed automatically.

Resuming operation

1 Set the power switch to ON.

- Normal Restart

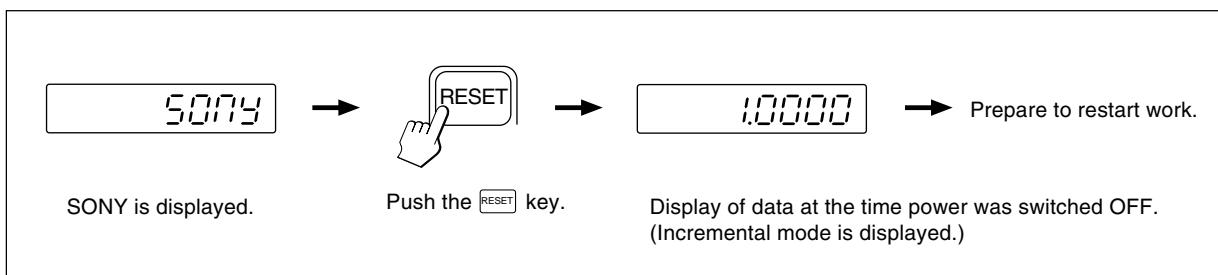

- When the stored data is erroneous

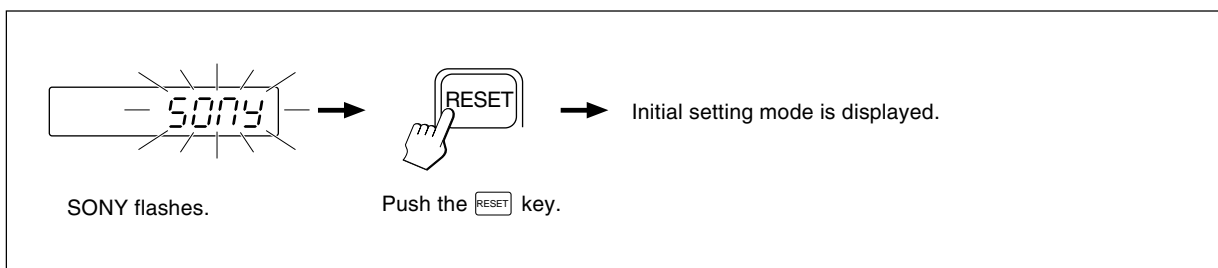

2 Unlock the Machine and Resume operation

5-6. Basic Operations

5-6-1. Presetting

Machining by counting down to zero

Example: Counting down while moving from P₀ to P₁.

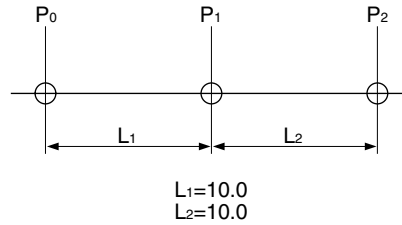

Note

In the display example below, the resolution is set to 0.0005 mm.

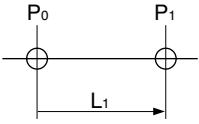
Operating procedure	Display
<p>Positioning to P₁</p> <p>X Select the X-axis.</p> <p>1 0 Enter the value L₁.</p> <p>Note To count up while moving from P₀ to P₁, enter -10.</p> <p>P Preset the input value. The INC indicator lights.</p>	<p>ABS, INC lights up</p> <p style="text-align: center;">- - - - -</p> <p>ABS, INC lights up</p> <p style="text-align: center;">10.</p> <p style="text-align: center;">10.0000</p> <p style="text-align: center;">↓ Counting</p> <p style="text-align: center;">0.0000</p>
 <p>Move the scale until "0" is displayed to reach P₁.</p>	

5-6-2. Recalling preset data

Pitch-feed machining

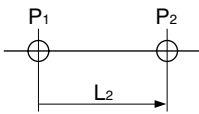
Operating procedure	Display
<p>Positioning to P₂</p> <div style="display: flex; flex-direction: column; align-items: center;"> <div style="border: 1px solid black; padding: 5px; margin-bottom: 10px;">X</div> <p>Select the X-axis.</p> <div style="border: 1px solid black; padding: 5px; margin-bottom: 10px;">P</div> <p>Press the Preset key. The INC indicator lights.</p> </div>	<p>ABS, INC lights up</p> <p style="text-align: center;">-----</p> <p style="text-align: center; font-size: 2em;">10.0000</p> <p style="text-align: center;">↓ Counting</p> <p style="text-align: center; font-size: 2em;">0.0000</p>
<div style="display: flex; align-items: center;">  <div style="margin-left: 20px;"> <p>Move the scale until "0" is displayed to reach P₂.</p> </div> </div>	

5-6-3. Datum point setting and display mode selection

This counter unit has two display modes: the absolute mode (ABS) in which the absolute distance between the datum point and the spot position is displayed, and the incremental mode (INC) in which the distance between the previous machining position and the spot position is displayed with a reset or preset operation.

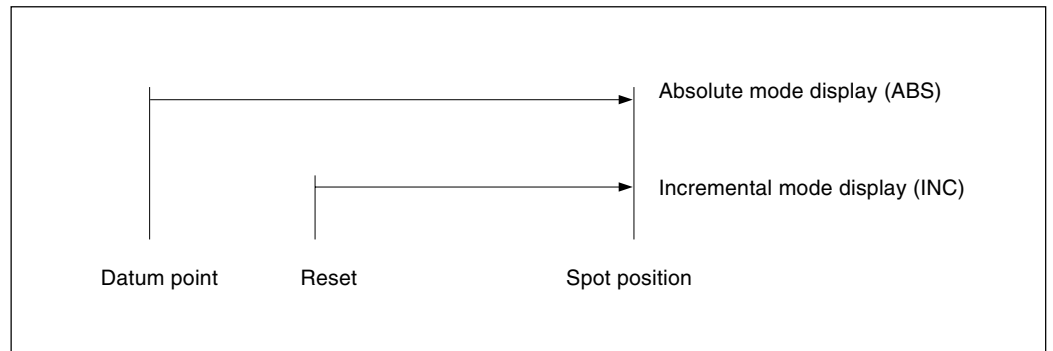

The conversion between the absolute mode (ABS) and incremental mode (INC) can be made by pressing:



Example: on X-axis

To restore the original display mode, perform the same operation.

If the display mode selection key is pressed directly without pressing an axis selection key, all axes are switched simultaneously. When both absolute mode (ABS) and incremental mode (INC) are set, switching is based on the more common display mode. (For example, when X-axis = ABS, Y-axis = INC and Z-axis = ABS, the X-, Y- and Z-axes are all switched to INC.) If the same number of both display modes are set, switching is based on the higher order axis. (For example, when X-axis = INC and Y-axis = ABS, the X- and Y-axes are both set to ABS.)

Setting datum point and display mode selection

Example: Counting down while moving from P₀ to P₁.

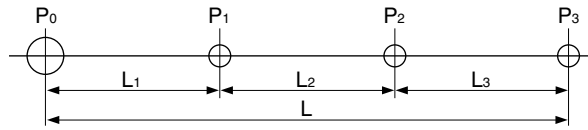







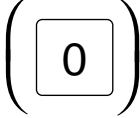

$$L_1=L_2=L_3=1.0$$

$$L=L_1+L_2+L_3=3.0$$

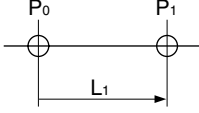
Note

In the example below, the resolution is set to 0.0005 mm.







Operating Procedure	Display
 <p>Select the X-axis.</p>  <p>“0” input can be omitted. To give an offset value to the datum point, enter the offset value instead of “0”.</p>  <p>Press the datum point setting key. The ABS indicator lights.</p>	<p>ABS, INC lights up</p> <p>-----</p> <p>ABS, INC lights up</p> <p>0.</p> <p>0.0000</p>
 <p>Select the X-axis.</p>  <p>Enter the value L₁.</p> <p>Note To count up while moving from P₀ to P₁, enter “-1”.</p>  <p>Press the preset key. The INC mode is entered.</p>  <p>Move the scale until “0” is displayed: P₁ is the position where “0” is displayed. Perform P₂ and P₃ positioning in the same way.</p>	<p>ABS, INC lights up</p> <p>-----</p> <p>ABS, INC lights up</p> <p>1.</p> <p>1.0000</p> <p>↓ Counting</p> <p>0.0000</p>
<p>To find the distance between P₀ and P₃ at the end of P₃ machining</p>  <p>Select the X-axis.</p> <p>Note If an axis is not selected, all axes are switched simultaneously.</p>  <p>Press the display mode selector key. The ABS indicator lights and the distance between P₀ and P₃ is displayed.</p>	<p>ABS, INC lights up</p> <p>-----</p> <p>- 3.0000</p>
<p>To restore the Previous mode</p>  <p>Press the same operation keys again to return to INC mode.</p> <p>Note If an axis is not selected, all axes are switched simultaneously.</p>  <p>The INC indicator is switched.</p>	<p>ABS, INC lights up</p> <p>-----</p> <p>0.0000</p>

5-6-4. Mid-point calculation

When the INC mode display is selected, the distance from the center value is displayed by halving the displayed value.

Note

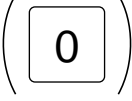
In the example, the resolution is set to 0.0005 mm.

Operating procedure	Display
<p>  If the ABS mode display is selected, change it to the INC mode before operating. </p> <p>The present value is displayed.</p> <p>  Select the X-axis. </p> <p>  Press the 1/2 key. The INC indicator lights. </p> <p> Move the machining table until the display reads "0". This position is the center. </p>	<p>(10.0000)</p> <p>10.0000</p> <p>ABS, INC lights up -----</p> <p>5.0000</p> <p>↓ Counting</p> <p>0.0000</p>
<p>To make the center position the datum point, operate as follows</p> <p>  Select the X-axis. </p> <p>  "0" input can be omitted. </p> <p>  Press the datum point setting key. The ABS indicator lights. </p> <p>Note If the operation above is performed, the preset datum point is canceled.</p>	<p>ABS, INC lights up -----</p> <p>ABS, INC lights up (0.)</p> <p>0.0000</p>

5-7. Applied Operations

5-7-1. Bolt hole circle and simple R cutting functions (2 or 3 axes display only)

Bolt hole circle function

Select diameter for the bolt hole circle function.

The hole positions are displayed sequentially around the circumference of the circle by entering the diameter, number of divisions and the starting angle.

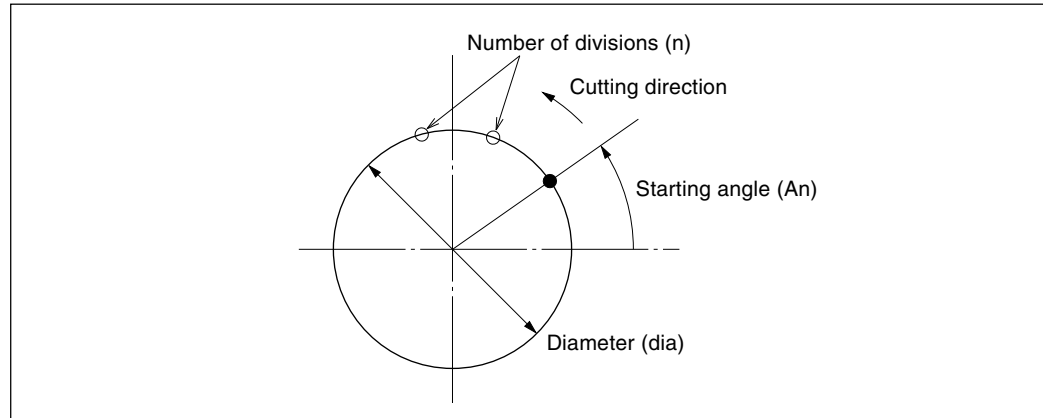

Simple R cutting function

Select Radius for the simple R cutting function.

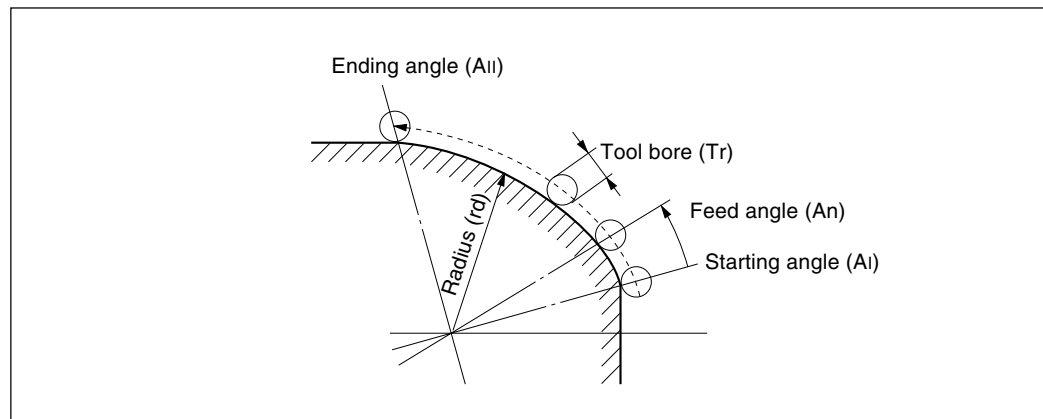

The arc undercutting positions are displayed sequentially by entering the radius, tool bore and feed angle.





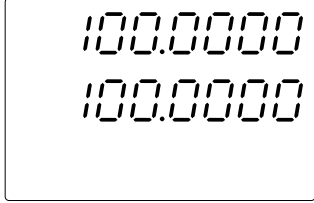
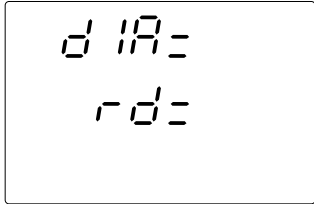
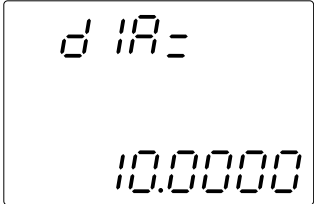
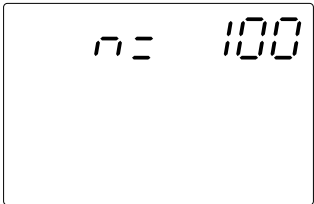
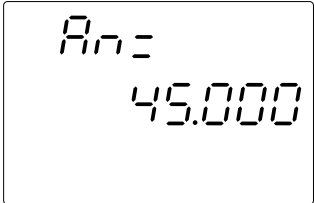

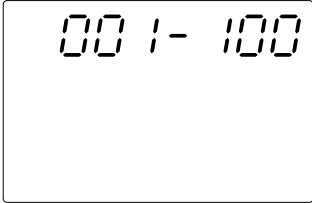
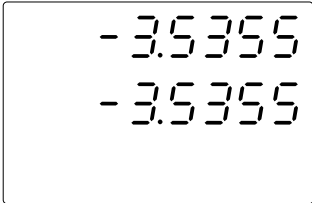
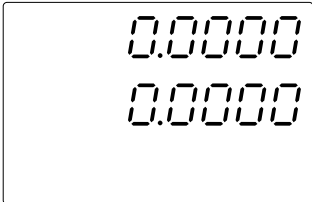

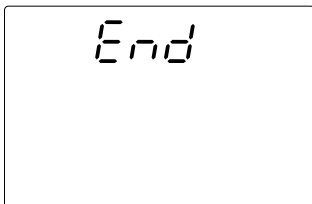

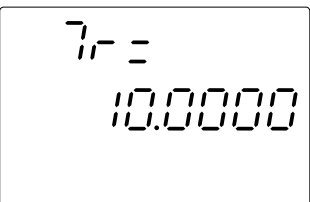
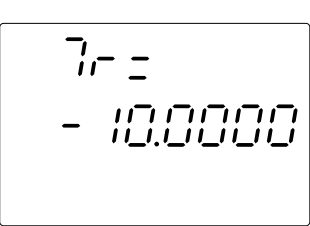
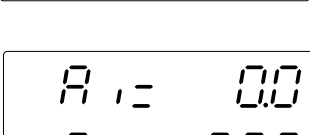
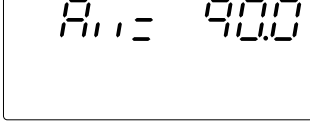
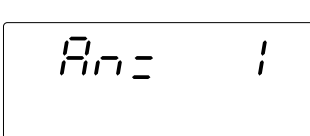
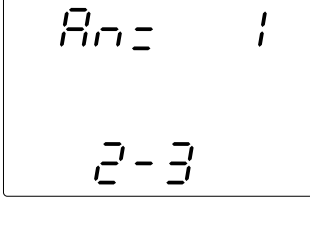
Reducing the feed angle produces a cleaner finish.



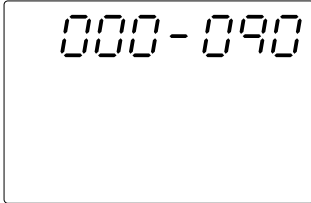

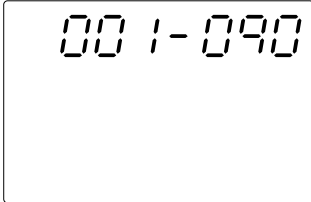
Also, for 3-axis display, the arc undercutting position display can be selected for the X-Z and Y-Z planes in addition to the X-Y plane.

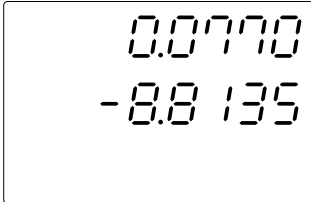
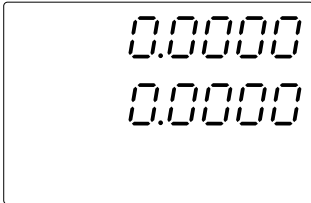
Operating Procedure	Display
<p style="text-align: center;">F</p> <p>Press the F key to set the BH/ARC mode.</p> <p>Enter the center point.</p> <p>X 1 0 0 P For X=100 mm</p> <p>Y 1 0 0 P For Y=100 mm</p> <p style="text-align: center;">Note</p> <p>Align the scale position with the center of the circle before starting.</p> <p style="text-align: center;">SET / L</p> <p>Press the Function setting key. The BH/ARC data input mode is entered.</p>	<div style="border: 1px solid black; padding: 5px; text-align: center;">  </div> <p style="text-align: right;">BH/ARC ● Lights up</p> <div style="border: 1px solid black; padding: 5px; text-align: center; margin-top: 20px;">  </div> <p style="text-align: right;">BH/ARC ● Lights up</p>
<p>[When the bolt hole circle function is selected]</p> <p style="text-align: center;">X</p> <p>Select diameter (<i>d IR</i>).</p> <p>For a diameter of 10 mm</p> <p>1 0</p> <p>Press the number keys.</p> <p>P</p> <p>Press the Preset key.</p> <p>For a division number of 100</p> <p>1 0 0</p> <p>Press the number keys.</p> <p>P</p> <p>Press the Preset key. (Maximum 360 divisions, corresponding to 360°.)</p> <p style="text-align: center;">Note</p> <p>Angle calculations are performed in 0.01° units. 0.001° units are calculated by linear interpolation using the 0.01° unit values. Therefore, a hole position error occurs if division results in a fraction less than 0.01°.</p> <p>For a starting angle of 45°</p> <p>4 5</p> <p>Press the number keys.</p> <p>P</p> <p>Press the Preset key. (0° to 359.999°, in 0.001° units)</p>	<div style="border: 1px solid black; padding: 5px; text-align: center;">  </div> <p style="text-align: right;">BH/ARC ● Lights up</p> <div style="border: 1px solid black; padding: 5px; text-align: center; margin-top: 20px;">  </div> <p style="text-align: right;">BH/ARC ● Lights up</p> <div style="border: 1px solid black; padding: 5px; text-align: center; margin-top: 20px;">  </div> <p style="text-align: right;">BH/ARC ● Lights up</p>

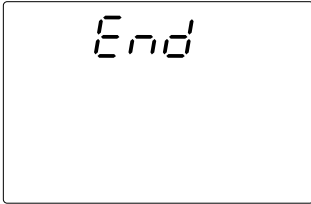
Operating Procedure	Display
<p>  </p> <p>Press the Execute key to start the BH program.</p> <p>Note The position of the No.1 hole is displayed. The bolt circle mode LED flashes.</p> <p>Move the X- and Y-axis scales so that the display becomes "0".</p>	<p>  </p> <p style="text-align: right;">BH/ARC ● Lights up</p> <p style="text-align: center;">↓ After approx. 2 seconds</p> <p>  </p> <p style="text-align: right;">BH/ARC ● Flashes</p> <p style="text-align: center;">↓</p> <p>  </p> <p style="text-align: right;">BH/ARC ● Lights up</p>
<p>  </p> <p>Press the Execute key. The position of the No. 2 hole is displayed.</p> <p style="text-align: center;">⋮</p> <p>  </p> <p>After processing of the last hole is finished, press the Execute key to End the operation.</p>	<p style="text-align: center;">⋮</p> <p>  </p> <p style="text-align: right;">BH/ARC ● Lights up</p>

Operating Procedure	Display
<p>[When simple R cutting is selected]</p>	
<p>Y Select radius (r_d).</p>	 <p>BH/ARC ● Lights up</p>
<p>For a radius of 500 mm</p> <p>5 0 0 P</p>	
<p>For a tool bore of 10 mm</p> <p>1 0 P Enter "+" when cutting the outer diameter.</p>	 <p>BH/ARC ● Lights up</p>
<p>(± 1 0 P Enter "-" when cutting the inner diameter.)</p>	 <p>BH/ARC ● Lights up</p>
<p>For a starting angle of 0°</p> <p>0 P (0° to 359.9° in 0.1° units)</p>	 <p>BH/ARC ● Lights up</p>
<p>For an ending angle of 90°</p> <p>9 0 P (0° to 359.9° in 0.1° units)</p>	
<p>For a feed angle of 1°</p> <p>1 P (1° to 10° in 1° units)</p>	 <p>BH/ARC ● Lights up</p>
<p>For 3 axes display</p> <p>Z Each time the "Z" key is pressed, the selected plane changes in the order of 1-3 (X-Z plane), 2-3 (Y-Z plane) and 1-2 (X-Y plane).</p>	 <p>BH/ARC ● Lights up</p>

Operating Procedure	Display
 <p>Press the Execute key. The start position is displayed.</p> <p>000 - 090</p> <p>Ending angle (1° units) Cutting position (1° units)</p> <p>Move the X- and Y-axis scales until "0" is displayed.</p>	 <p>BH/ARC ● Lights up</p> <p>After approx. 2 seconds</p>  <p>BH/ARC ● Flashes</p>
 <p>Press the Execute key. Next cutting position is displayed. Move the X- and Y-axis scales until "0" is displayed.</p>	 <p>BH/ARC ● Lights up</p>
 <p>Press the Execute key. Next cutting position is displayed. Move the X- and Y-axis scales until "0" is displayed.</p>	 <p>BH/ARC ● Flashes</p>
<p>⋮</p>	 <p>BH/ARC ● Lights up</p> <p>⋮</p>
 <p>⋮</p> <p>After processing of the last position is finished, press the Execute key to End the operation.</p>	 <p>BH/ARC ● Lights up</p>

Operating Procedure	Display
<p>Repeat BH/ARC Mode</p>  <p>If an operation is performed when End is displayed, the display will return to the present values. However, the scale does not exit BH/ARC function mode. If the scale is moved to the center coordinates and the Execute key is pressed again, the operation is repeated using the same parameters.</p>	
<p>End BH/ARC mode</p>  <p>If an operation is performed when End is displayed, the display will return to the present values.</p>	
<p>Cancel BH/ARC mode</p>  <p>If an operation is performed while the BH/ARC function mode is in progress, the display returns to the present values. The BH/ARC and REF-LEDs all go out.</p>	

5-7-2. Touch sensor (option)

- Attach the Touch sensor on the main spindle of a milling machine, for example, and use it in combination with the counter unit.
- The feeler ball of the Touch sensor is semi-fixed by a spring and its flexible construction can absorb shock when pressed against the datum plane, which enables accurate datum point detection without causing a deflection on the axis.
- The feeler ball, which has been forced against the workpiece, returns to the center of the axis when the workpiece is moved off.
- Move off the Touch sensor immediately from the workpiece when it touches the workpiece. Do not bring the shaft into contact with the workpiece as doing so will decrease precision and may cause damage.
- The Touch sensor can operate only with an electroconductive workpiece. Check the workpiece material before use.

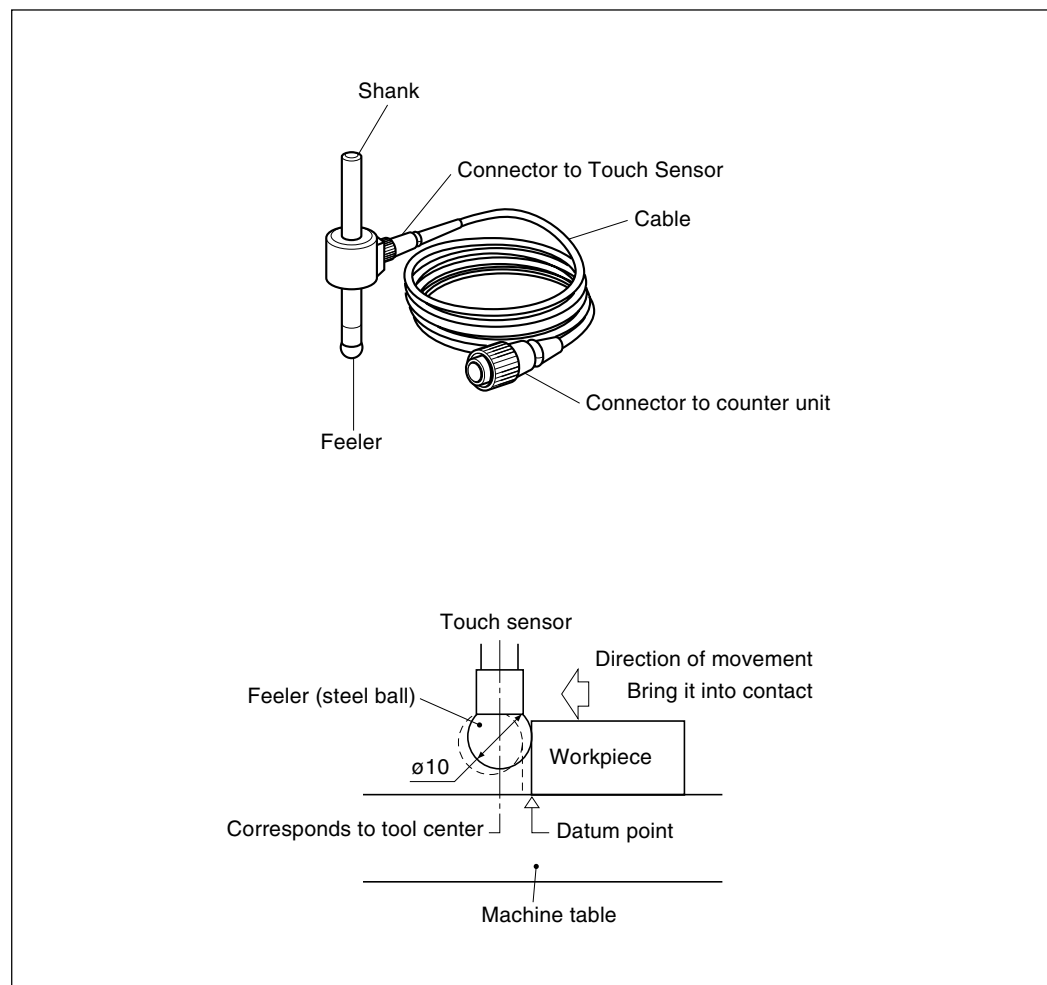

1. Cautions

- Before use, be sure to turn the steel ball with the fingers about the axis of the shaft 2 or 3 times both clockwise and counterclockwise so that the steel ball rests properly on the end of the shaft. If this not done, the rust-preventive grease between the steel ball and shaft might cause a detection error.

Note

- Do not turn the steel ball more than 180° in either direction since a spring is connected to it.
- Do not pull the steel ball and let it spring back sharply against the end of the shaft.

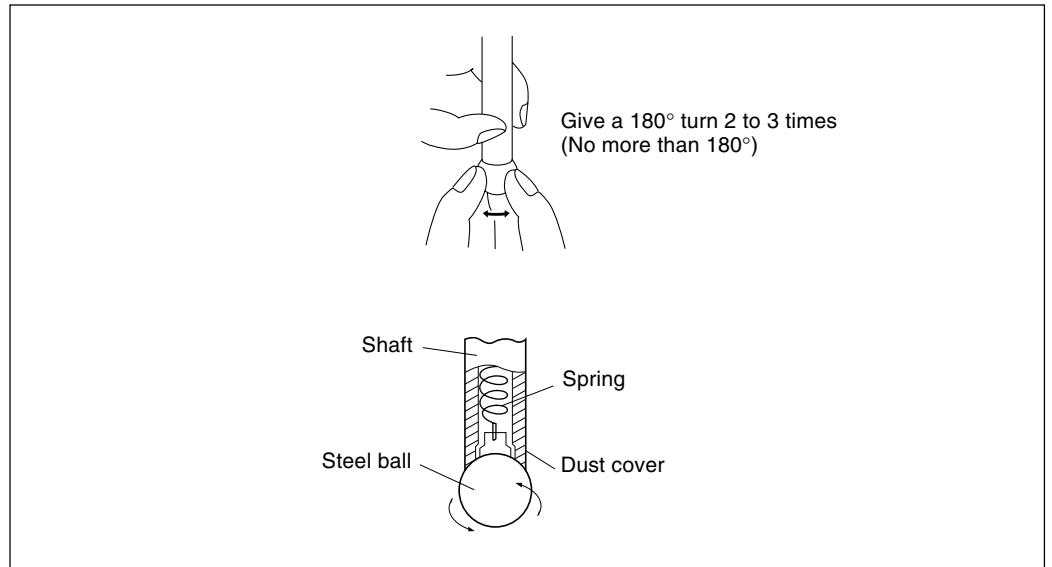

- Fix the shank to the main spindle in such a way that the shank is not inclined against the axis of the spindle, since inclination of the shank will cause errors in the measurement.
- For more precise positioning at the center of the workpiece: Touch the workpiece with the feeler ball ①. Then, move the touch sensor to the other side of the workpiece, rotate the shank holder of the machine through 180° and then touch the workpiece ②. Half the measured value is the center of the workpiece.

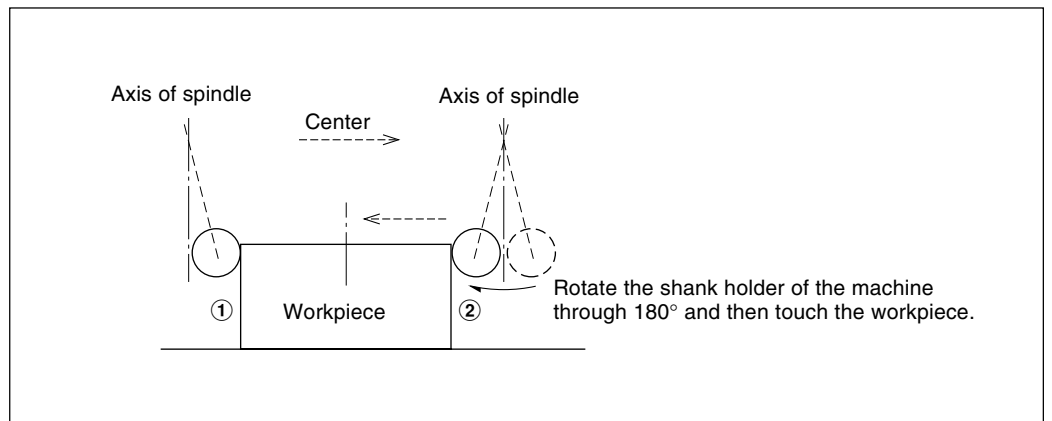

- There are two ways to use the Touch Sensor: one is for establishing the datum point and the other is for measuring a workpiece without destroying the datum point.

Absolute mode (ABS)

This is a mode for establishing a datum point. A datum point can be established or a distance from the datum point can be measured by the LOAD/HOLD operation.

Incremental mode (INC)

In this mode, a datum point can not be established.

Pitch measurement of a workpiece can be performed by the LOAD/HOLD operation without destroying the datum point which has been already established.

- Depending on usage, set the display mode to INC or ABS with display mode switching controls before starting the actual controls.
- In the following examples , the resolution is 0.0005mm, and the feeler ball of the touch sensor is 10mm across.
- If a load or hold operation has been erroneously performed, press the relevant Axis selector key and the  key to cancel the operation, and perform the load or hold operation again.
- Be sure to touch the machine table with the touch sensor feeler ball gently. If the feeler ball touches the table roughly, the feeler ball and the table may be damaged.

2. Specifications

Model	TS-103A	TS-105A	TS-110A	TS-203A	TS-205A	TS-210A	TS-303A	TS-305A	TS-310A
Shank dia. and length	ø10 × 45 mm or 0.3937 in dia. × 1.772 in			ø12.7 × 45 mm or 0.5 in dia. × 1.772 in			ø32 × 55 mm or 1.260 in dia. × 2.165 in		
Detection direction	±X, ±Y								
Feeler	Steel ball, ø10 mm or 0.3937 in dia.			Steel ball, ø12.7 mm or 0.5 in dia.			Steel ball, ø10 mm or 0.3937 in dia.		
Accuracy	0.002 mm or 0.0001 in			0.002 mm or 0.0001 in			0.002 mm or 0.0001 in		
Overall length	110 mm or 4.331 in			110 mm or 4.331 in			120 mm or 4.724 in		
Cable length	3m or 10 ft	5m or 16.7 ft	10m or 33.3 ft	3m or 10 ft	5m or 16.7 ft	10m or 3.3 ft	3m or 10 ft	5m or 16.7 ft	10m or 33.3 ft
Remarks	The cable and the Touch Sensor itself are connected/disconnected through the connector.								

3. Maintenance





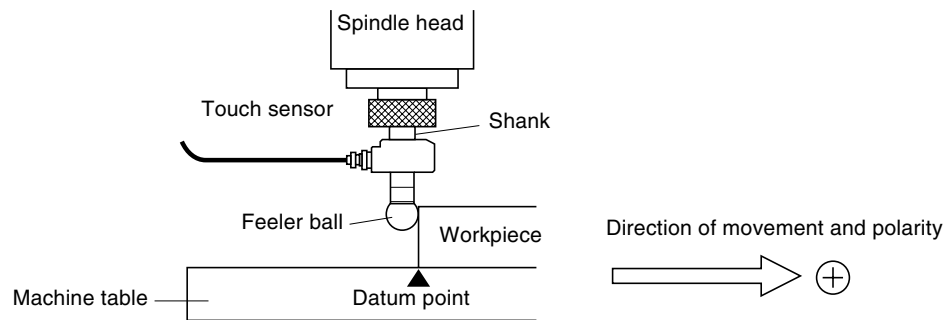

If the sensor is left unused for a long period, be sure to apply a rust-preventive. Especially, if the steel ball or shank rusts, the accuracy will be affected.

Rust Veto Heavy by E. F. Houghton & Co. is recommended as a rust preventive oil.

4. Touch sensor operations



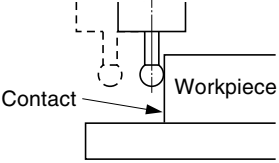

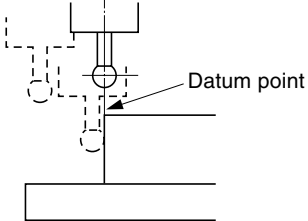



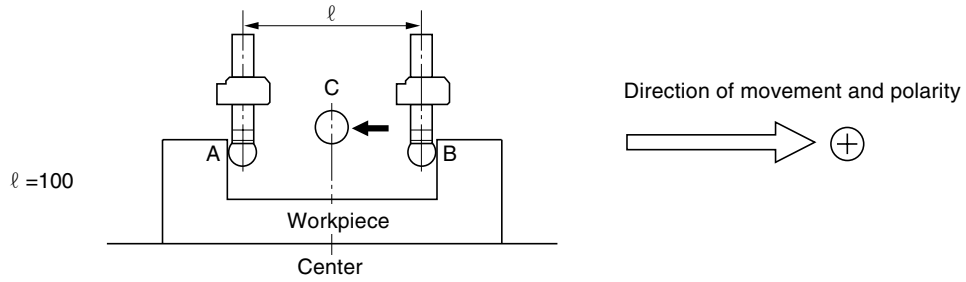





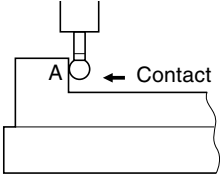

Setting of datum point

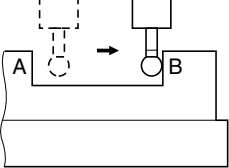

Operating Procedure	Display
<p>  Select the X-axis. Note If an axis is not selected, all axes are switched simultaneously. </p> <p>  Set the absolute mode (ABS). (The spot position is displayed.) The ABS indicator lights. </p>	<p>ABS, INC lights up</p> <p>-----</p> <p>0.0000</p>
<p>  Select the X-axis again. </p> <p>  Press the LOAD key to prepare for setting the datum point. The LED (LOAD/HOLD) indicator flashes. </p>	<p>ABS, INC lights up</p> <p>-----</p> <p>-5.0000</p> <p> Flashes</p>
<p>  Bring the feeler of the Touch sensor into contact with the workpiece. Upon contact, the buzzer sounds and counting starts. The LED (LOAD/HOLD) indicator goes out. </p>	<p>Buzzer</p> <p></p> <p>-5.0000</p> <p> Goes out</p>
<p>  Move the Touch sensor. The position where the displayed value is "0" is the datum point. Press the in/mm selector switch, if necessary, to perform inch operation. </p>	<p>Counting</p> <p>↓</p> <p>0.0000</p>

Centering of workpiece

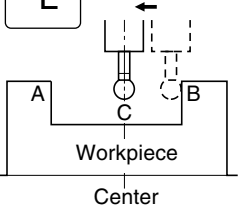

Operating Procedure	Display
<p>   </p> <p>Select the X-axis.</p> <p>Note If an axis is not selected, all axes are switched simultaneously.</p> <p>Set the absolute mode (ABS). (The spot position is displayed.)</p>	<p>ABS, INC lights up</p> <p>-----</p> <p>0.0000</p>
<p>   </p> <p>Select the X-axis again.</p> <p>Press the LOAD key. The LED (LOAD/HOLD) indicator flashes.</p>	<p>ABS, INC lights up</p> <p>-----</p> <p>5.0000</p> <p> Flashes</p>
<p>  </p> <p>Touch the surface A of the workpiece with the feeler of the Touch sensor. On contact the buzzer beeps and counting starts. The LED (LOAD/HOLD) indicator goes out.</p>	<p>Buzzer</p> <p></p> <p>5.0000</p> <p> Goes out</p>
<p>   </p> <p>Select the X-axis.</p> <p>Press the HOLD key. It is ready for holding the display "0". The LED (LOAD/HOLD) indicator flashes.</p>	<p>Buzzer</p> <p></p> <p>Counting</p> <p> Flashes</p>
<p>  </p> <p>Move the Touch sensor to touch the surface B. On contact the buzzer beeps and the display is held. The LED (LOAD/HOLD) indicator lights.</p>	<p>100.0000</p> <p> Lights up</p>
<p>    </p> <p>Select the X-axis.</p> <p>Depress the 1/2 key. The HOLD mode is released. The value displayed hereupon is the distance from the workpiece center C. The LED (LOAD/HOLD) indicator goes out. It is ready for centering.</p> <p>Move the Touch sensor toward the workpiece center C. The position where the displayed value is "0" is the center.</p>	<p>45.0000</p> <p> Goes out</p> <p>Counting</p> <p>0.0000</p>

Inside and outside measurements of workpiece

Inside measurement $L_1 = \ell_1 + 10\text{mm}$

Outside measurement $L_2 = \ell_2 - 10\text{mm}$

Example: $L_1 = 100$

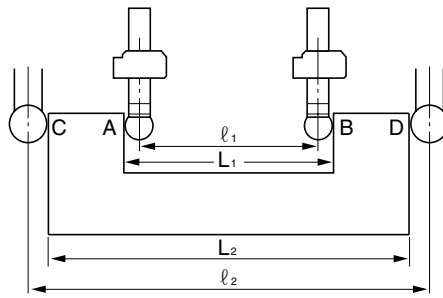













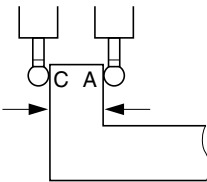

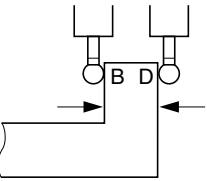

Direction of movement and polarity
 direction

The display below shows the inside measurement.

Note

Make following measurements in millimeter operation.
 Depress the in/mm selector key if necessary.

Operating Procedure	Display
<p>()</p> <p>Select the X-axis. Note If an axis is not selected, all axes are switched simultaneously.</p> <p> $\frac{F}{\pm 1}$</p> <p>Set the incremental mode (INC). (The spot position is displayed.)</p> <p> </p> <p>Select the X-axis again.</p> <p> </p> <p>Depress the LOAD key. It is ready for setting the datum point on the side A (side C). The LED (LOAD/HOLD) indicator flashes.</p>	<p>ABS, INC lights up</p> <p>-----</p> <p>2.3400</p> <p>ABS, INC lights up</p> <p>-----</p> <p>5.0000  Flashes</p>
<p></p> <p>Touch the side A (side C) with the feeler. On contact the buzzer beeps and counting starts. The LED (LOAD/HOLD) indicator goes out.</p> <p>Before touching the side B (side D), select the X-axis and press the HOLD key.</p> <p> </p> <p>It is ready for finding L_1 (L_2). The LED (LOAD/HOLD) indicator flashes.</p>	<p>Buzzer </p> <p>5.0000  Goes out</p> <p>Counting starts</p> <p>Buzzer </p> <p> Flashes</p>
<p></p> <p>Touch the side B (side D) of the workpiece with the feeler. The buzzer beeps and the displayed value is held, which is the value L_1 (L_2). The LED (LOAD/HOLD) indicator lights.</p>	<p> Flashes</p> <p>100.0000  Lights up</p>
<p> </p> <p>Select X-axis again and press the cancel key. The hold is canceled and the display will show the present value. The LED (LOAD/HOLD) indicator goes out.</p> <p></p>	<p>123.6780  Goes out</p>

5-7-3. Detecting function of absolute zero point of scale

- This function is valid in combination with a scale with built-in absolute zero point. Once the distance L between the machining datum point and the absolute zero point of the scale is found, the machining datum point can be relocated easily for repeated machining.
- When the unit is set to the detecting mode of the absolute zero point of the scale, the REF lights up and the ABS mark are displayed.
- If a load or hold operation has been erroneously performed, press the relevant Axis selector key and the  key to cancel the operation, and perform the load or hold operation again.

Fig.1 Scale with built-in absolute zero point and machine movement

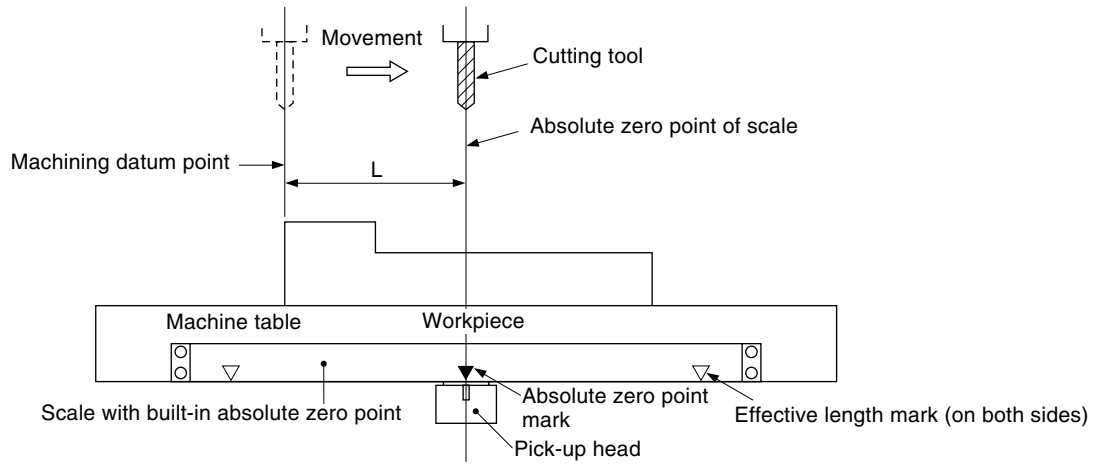

Fig.2 Setting of datum point

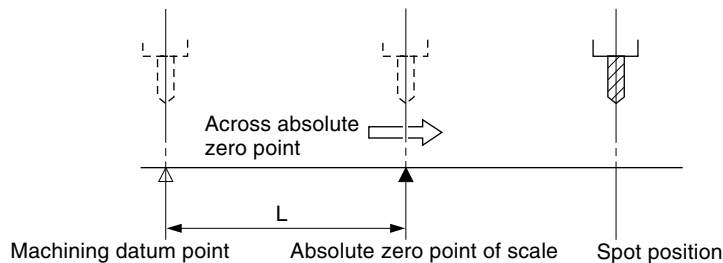
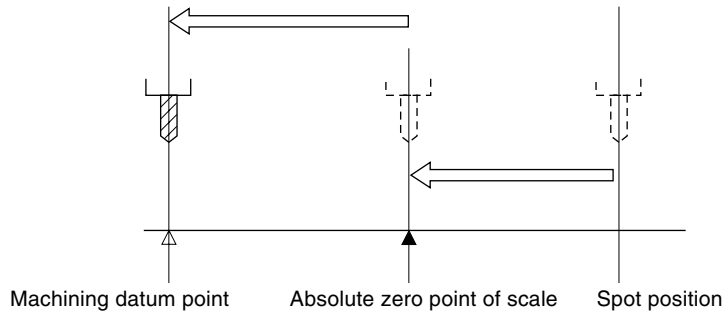

Fig.3 Relocation of datum point

After the absolute zero point is passed, move the cutting tool back to the machining datum point.











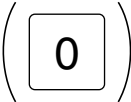

Operation



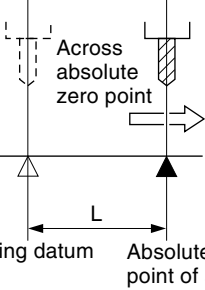



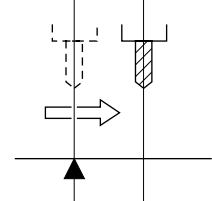



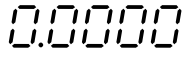

Note

The display example shows the case where the resolution is set to 0.0005 mm.

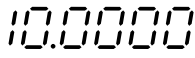
Setting of datum point

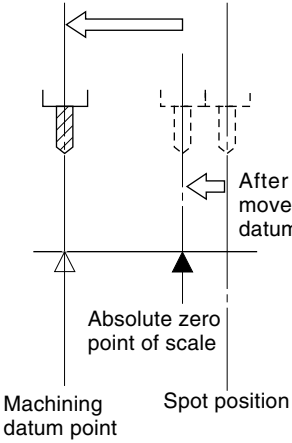
Operating Procedure	Display
<p> Select the X-axis.</p> <p> "0" input can be omitted.</p> <p> Press the datum point setting key.</p> <p>  Check that the REF lamp is on. When it is not lighted, press the  key twice to turn on the absolute zero point detection mode indicator.</p> <p> Select the X-axis again.</p> <p> Press the HOLD key. (It is ready for holding the displayed value of the distance L between the machining datum point and the absolute zero point of scale.) The LED (LOAD/HOLD) indicator flashes.</p>	<p>ABS, INC lights up -----</p> <p>ABS, INC lights up (0.)</p> <p>0.00000</p> <p>0.00000</p> <p>ABS, INC lights up -----</p> <p>0.00000</p> <p>REF ● Lights up</p> <p>REF ● Lights up</p> <p>L/H Flashes</p>
<p> The value displayed the moment the absolute zero point of the scale is passed is held. The LED (LOAD/HOLD) indicator lights.</p> <p>Machining datum point Absolute zero point of scale</p>	<p>Buzzer</p> <p></p> <p>10.00000</p> <p>L/H ● Lights up</p>
<p> Select the X-axis.</p> <p> Press the HOLD key to release the HOLD mode. The spot position is displayed. Here, the hold value is stored internally.</p> <p> Absolute zero point of scale Spot position</p>	<p>ABS, INC lights up -----</p> <p>REF ● Lights up</p> <p>(Example)</p> <p>12.00000</p> <p>REF ● Lights up</p>

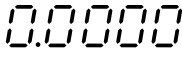
Relocation of datum point

Operating Procedure	Display
<p>  </p> <p>Check that the REF lamp is on. When it is not lighted, press the  key twice to turn on the absolute zero point detection mode indicator.</p> <p>  </p> <p>Select the X-axis again.</p>	<p>   REF ● Lights up </p> <p> ABS, INC lights up   REF ● Lights up </p>
<p>  </p> <p>Press the LOAD key. “L=10.0000 mm/0.39370 in,” the distance between the machining datum point and the absolute zero point of scale, is displayed. The LED (LOAD/HOLD) indicator flashes.</p>	<p>   L/H ● Flashes </p>
<p>  </p> <p>As soon as the absolute zero point of scale is passed, the counting starts. The LED (LOAD/HOLD) indicator goes out. The position where the displayed value is “0” is the datum point.</p> <p>After the absolute zero point is passed, move the cutting tool back to the machining datum point.</p> <p>Absolute zero point of scale</p> <p>Machining datum point</p> <p>Spot position</p>	<p>Buzzer</p> <p>  Counting starts </p> <p>↓</p> <p>   L/H ○ Goes out </p>

5-7-4. Offset zero point

The offset zero point function is to set the distance (offset value) between the absolute zero point of scale and the datum plane of the machine table in the counter unit beforehand, which makes zero point setting on a boring machine and the like easy and effective.

Note

Also notice that, in the offset zero point function, the memorized L value in the datum point setting is changed to the offset value ΔY .

On the other hand, when L is stored into memory when setting the datum point, the offset value ΔY is changed to L.

Measurement of offset Value

Using the Touch sensor (option), measure the distance ΔY (offset value) between the absolute zero point of the scale and the datum plane of the machine table.

This is the most suitable method for obtaining a high-accuracy offset value without damaging the machine table surface.

This section describes the method which uses our Touch sensor. See page 5 for Touch sensor connection and page 40 for the specifications. Measuring examples are shown below.

Notes on measurement

Do not bring the machine spindle directly into contact with the machine table surface for measurement, as this may cause damage to the spindle and the table surface.



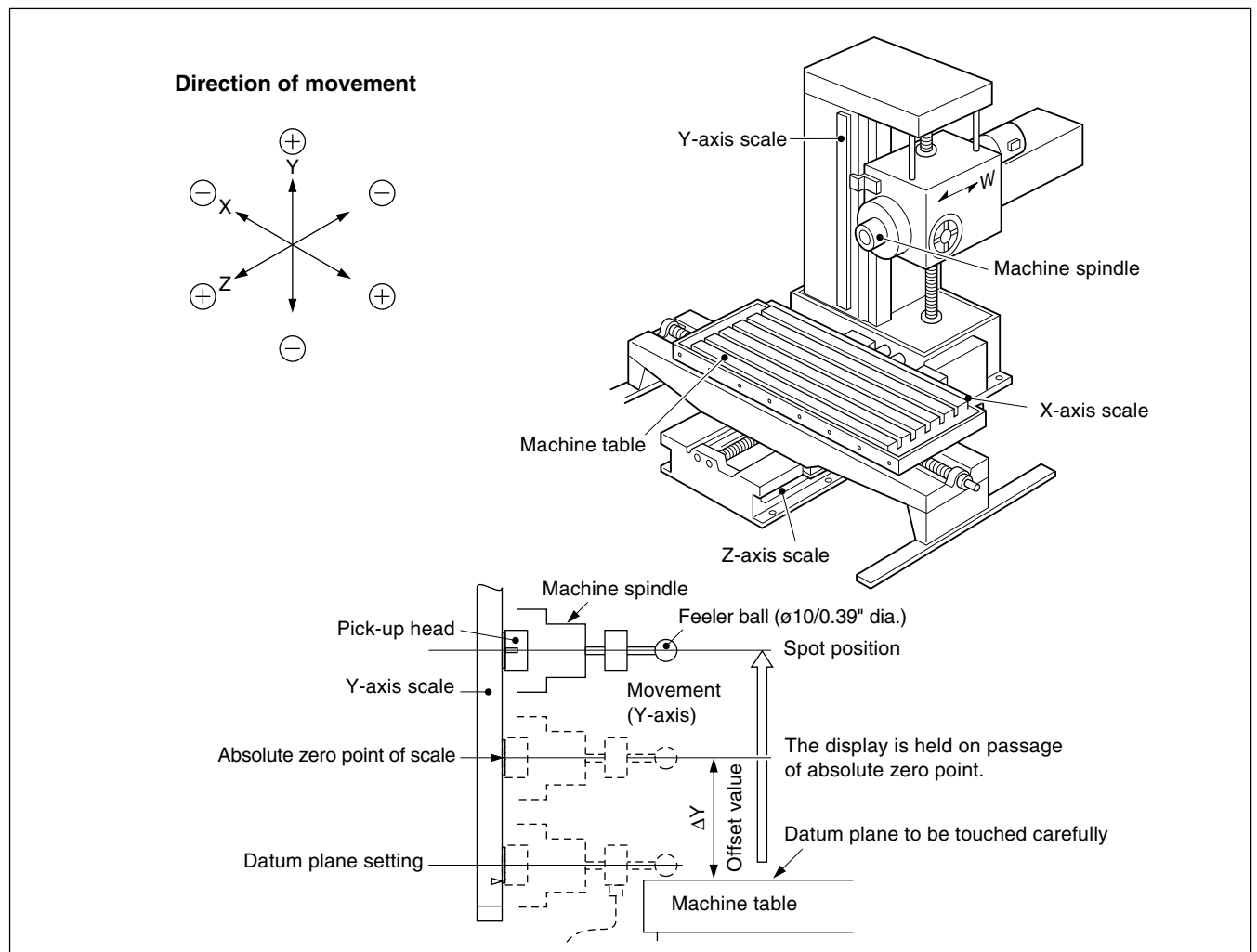







Example: Y-axis machining on the horizontal boring machine

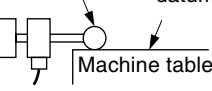

Measurement of the offset value ΔY

Note

In the example shown below, the resolution is set to 0.0005 mm.







Operating Procedure	Display
<div style="display: flex; flex-direction: column; align-items: flex-start;"> <div style="margin-bottom: 20px;">  <p>Select the Y-axis.</p> <p>Note If it is in the INC mode, switch to the ABS mode.</p> </div> <div>  <p>Press the LOAD key. The LED (LOAD/HOLD) indicator flashes.</p> </div> </div>	<p>ABS, INC lights up</p> <p style="text-align: center;">-----</p> <p style="text-align: center; font-size: 24px;">5.0000</p> <div style="text-align: right;">  <p>Flashes</p> </div>
<div style="display: flex; flex-direction: column; align-items: flex-start;"> <div style="margin-bottom: 20px;"> <p>Touch the machine table carefully.</p> <div style="display: flex; align-items: center;">  <div style="margin-left: 10px;"> <p>Setting of datum plane</p> <p>Machine table</p> </div> </div> </div> <div style="margin-bottom: 20px;"> <p>On contact of the feeler to the machine table, the buzzer beeps and the counting starts at the loaded display value. When the feeler touches the machining table, the buzzer sounds and the counting starts from the loaded display value. The LED (LOAD/HOLD) indicator turns off.</p> </div> <div style="margin-bottom: 20px;"> <p>Check that the REF lamp is on. When it is not lighted, press the  key twice to turn on the absolute zero point detection mode indicator.</p> </div> <div style="margin-bottom: 20px;"> <p>Select the Y-axis.</p> </div> <div> <p>Press the HOLD key. (It is ready for holding the value of the distance ΔY to the absolute zero point of scale.) The LED (LOAD/HOLD) indicator flashes.</p> </div> </div>	<p style="text-align: center;">Buzzer</p> <div style="text-align: center;">  <p>Counting starts</p> </div> <div style="text-align: center; margin-top: 100px;"> <p>Buzzer</p>  </div> <div style="text-align: right; margin-top: 100px;">  <p>Flashes</p> </div>
<div style="display: flex; flex-direction: column; align-items: flex-start;"> <div style="margin-bottom: 20px;"> <div style="border: 2px solid black; padding: 5px; width: fit-content;"> <p>Note</p> <p>102.4700 mm or 4.03424 in</p> </div> <p>Offset value ΔY</p> </div> <div> <p>Move the machine spindle and make it pass over the absolute zero point of the scale. The LED (LOAD/HOLD) indicator lights up, the offset value ΔY is held. The LED (LOAD/HOLD) indicator lights.</p> <p>* By storing the held offset value ΔY in memory, ΔY can be set easily when the counter unit is replaced. Refer to "5-1-5. Setting the distance from the absolute zero point of the scale to the cutting datum point".</p> </div> </div>	<div style="text-align: center; margin-top: 100px;">  </div> <div style="text-align: center; margin-top: 100px;"> <p style="font-size: 24px;">102.4700</p> </div> <div style="text-align: right; margin-top: 100px;">  <p>Lights up</p> </div>
<div style="display: flex; flex-direction: column; align-items: flex-start;"> <div style="margin-bottom: 20px;">  <p>Select the Y-axis.</p> </div> <div> <p>Press the HOLD key. The held display is released, and the spot position is displayed. At this time, the hold value is stored internally.</p> </div> </div>	<p style="text-align: center;">Display of spot position</p> <p style="text-align: center; font-size: 24px;">123.6750</p> <div style="text-align: right;">  <p>Lights up</p> </div>

Operation of offset zero point

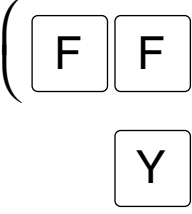
Note

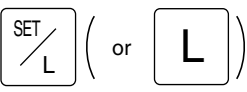
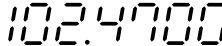
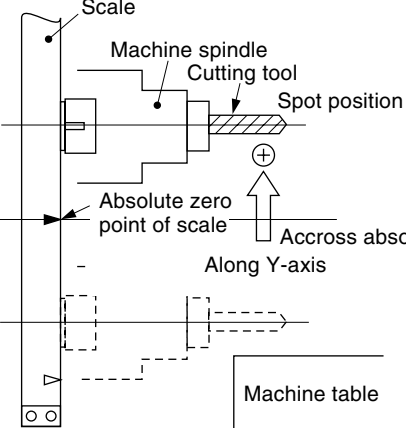
In the example shown below, the resolution is set to 0.0005 mm.

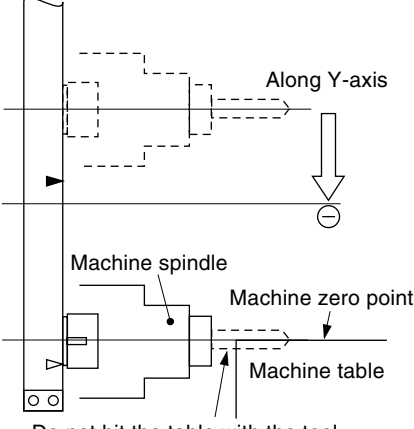
The following is an example of Y-axis operation. For X-, Z-axis, perform the same key operation for each axis.

Operating Procedure	Display
<p>  </p> <p>Check that the REF lamp is on. When it is not lighted, press the F key twice to turn on the absolute zero point detection mode indicator.</p> <p>Select the Y-axis.</p>	<p>  </p> <p>REF ● Lights up</p> <p>ABS, INC lights up</p> <p>REF ● Lights up</p>
<p>  </p> <p>Press the LOAD key.</p> <p>The offset value ΔY in the counter unit is displayed.</p> <p>The offset value ΔY stored in the counter unit is displayed.</p> <p>The LED (LOAD/HOLD) indicator flashes.</p>	<p>  </p> <p>L/H Flashes</p>
<p>  </p> <p>When the machine spindle is moved in the (+) direction along the Y-axis, and the absolute zero point of the scale is passed, the count is started, and the spot position is displayed. The LED (LOAD/HOLD) indicator goes out.</p>	<p>  </p> <p>Buzzer</p> <p>Counting starts</p>
<p>  </p> <p>Next, move the machine spindle toward the (-) side along the Y-axis. The position where the displayed value is "0" is the machine zero point.</p> <p>Note</p> <p>Be carefull not to hit the machine table with the tool when moving the machine spindle inthe (-) direction.</p> <p>Do not hit the table with the tool.</p>	<p>  </p> <p>L/H ○ Goes out</p>





5-8. Multiple Datum Point Function

The ABS coordinate value is registered by the datum point setting operation or absolute zero point loading operation, and 250 datum point offset values can be set based on this coordinate value.

The ABS coordinate value is set to datum point number 0. Set this value by the datum point setting operation or absolute zero point loading operation when datum point number 0 is selected on the display.

5-8-1. Setting the multiple datum point offset value (input while counting)

The procedure below shows the operations for using a number other than datum point number 0 and setting the datum point offset value.

Operation	Display
 <p>Press .</p>	<p>X No. 0 Y Z</p> <p>The datum point coordinate number is displayed.</p>
<p>Use the numeric keys to enter the multiple datum point number. (In this example, the number 2 is selected.) If you make a mistake when entering the number, press the  key to enter the number again.</p>	<p>X No. 2 Y Z</p> <p>The entered datum point number is displayed.</p>
 <p>Press .</p> <p>The multiple datum point number is registered, and the screen returns to the current value display.</p>	<p>X 30.0000 Y 2.0005 Z 0.0030</p> <p>The ABS indicator flashes to indicate that the multiple datum point coordinates have been moved. The ABS value of datum point number 0 is displayed.</p> <p>However, if the multiple datum point offset has already been entered, a new value is displayed by adding the offset to the ABS value of datum point number 0.</p>
<p>The multiple datum point offset value is set using the same procedure as the datum point setting procedure. (In this example, the setting is made for X = 40.000, Y = 0.000, and Z = 0.000.)</p>	<p>X 40.0000 Y 0.0000 Z 0.0000</p>





In this example, since the X-axis display before setting the datum point offset was 30.0000, an offset value of $40.0000 - 30.0000 = 10.0000$ is entered for number 2. Even if the datum point number 0 is reset at a later time, the offset of 10.0000 between datum point number 0 and 2 does not change.

Use the same procedure to make the settings for other numbers.

The display values in this procedure are the current values. As a result, these values will change if the scale moves. For this reason, pay careful attention to the offset value that is entered.







5-8-2. Checking the multiple datum point numbers in use







This operation is used to check which multiple datum point numbers are being used by the current value being displayed.

Operation		Display	
	Press  .	X Y Z	No. 2 The datum point coordinate number is displayed.
	Press  .	X Y Z	40.0050 0.0200 0.0040 The screen returns to the original display.

5-8-3. Editing the multiple datum point offset values (input in edit mode)





The operations described above are individual setting procedures for entering the offset after selecting the multiple datum point number to be used. In addition to these operations, there are also operations for entering and editing offset values for more than one number. This input operation is useful when all offset values are already known.

Operation		Display	
	Press  .	X Y Z	No. 2 The datum point coordinate number is displayed.
	Press  .	X Y Z	No. 2 The input screen for datum point numbers is displayed. (The lamp above  flashes.)
Use the numeric keys to enter the multiple datum point number. (In this example, the number 100 is selected.) If you make a mistake when entering the number, press the  key to enter the number again.		X Y Z	No. 100 The entered datum point number is displayed.

Operation		Display	
	Press  . The multiple datum point number is registered, and the datum point offset is displayed. (The ABS indicator turns on when the offset is already entered. The INC indicator will turn on if it has not been entered.)	X	0.0000
		Y	0.0000
		Z	0.0000
	Enter the offset value in the same manner as the datum point settings. (Press  to clear the entered offset. The offset for this number is reset to zero for all axes.)	X	200.0000
		Y	300.0000
		Z	200.0000
	Press  . The multiple datum point value is registered, and the screen returns to the number input display. The screen moves to the next number whose input has been completed. (In this example, the screen moves from 100 to 101.)	X	No. 101
		Y	
		Z	
	In the next steps, the offset value is entered in the same way as the other procedures.	X	No. 120
		Y	
		Z	
	(Exiting edit mode) Press  when "No." is displayed. The screen returns to the current value display. (The selected number here is the number used before editing was started.)	X	40.0050
		Y	0.0200
		Z	0.0040
		The screen returns to the original display.	

5-8-4. Checking the datum point offset values

The offset value can be checked in the procedure in 5-8-3. The exit operation after checking is shown below.

Operation		Display	
	Press  .	X	No. 100
	Note If this procedure is used to exit after the offset value has been changed, the offset value will not be updated and the offset setting will return to the original value.	Y	
		Z	
		The screen returns to the input display for the datum point number.	
	Press  to exit edit mode. The screen returns to the current value display. (The selected number here is the number used before editing was started.)	X	40.0050
		Y	0.0200
		Z	0.0040
		The screen returns to the original display.	

6. Linear Compensation

Generally a machine tool has its inherent geometric error.

For example, with a knee type milling machine, the knee is slightly tilted as the table moves and the horizontal component of this inclination is added to the scale displacement as an error. When the displayed value is obtained by

$$\boxed{\text{Scale reading}} + \boxed{\text{Error compensation}} \rightarrow \boxed{\text{Displayed value}}$$

corresponding to the actual displacement, the mechanical error is compensated and the more accurate display is obtained for the actual displacement of the machine table, thus attaining more accurate machining.

The unit is factory-set so that the linear compensation function does not work.

6-1. Setting Linear Compensation

The error compensation is made by adding or subtracting a compensation amount to or from the scale reading for every given table displacement.

Notes on the setting

- 1) The compensation amounts in Table below apply to a displacement of 1m for the millimeter operation and 1" for the inch operation. Be sure to set the compensation amount in the relevant operation. Precision machining and accurate measurement are not possible if a wrong compensation amount is set.
- 2) For a compensation amount not listed in the table, set the closest value.
- 3) Regarding the polarity, select a positive (+) compensation when the displayed value is smaller than the actual length and a negative (–) compensation when the displayed value is greater.

Linear compensation amount

Select any compensation amount per meter referring to the following table.

When initializing the compensation amount, its least significant three digits will be displayed.

Select an appropriate value from the table.

	Compeccation amount	Initial setting display		
	Per meter			
No compensation	0	LC	000	
Plus (+) setting	0.001 mm	LC	001	
	0.002 mm	LC	002	
	0.003 mm	LC	003	
	0.004 mm	LC	004	
	0.005 mm	LC	005	
	0.006 mm	LC	006	
	0.007 mm	LC	007	
	0.008 mm	LC	008	
	0.009 mm	LC	009	
	0.010 mm	LC	010	
	0.015 mm	LC	015	
	0.020 mm	LC	020	
	$\}$ (0.005 mm step) $\}$	$\}$ LC (005 step) $\}$		
	0.600 mm	LC	600	
Minus (-) setting	-0.001 mm	LC	-001	
	-0.002 mm	LC	-002	
	-0.003 mm	LC	-003	
	-0.004 mm	LC	-004	
	-0.005 mm	LC	-005	
	-0.006 mm	LC	-006	
	-0.007 mm	LC	-007	
	-0.008 mm	LC	-008	
	-0.009 mm	LC	-009	
	-0.0010 mm	LC	-010	
	-0.0015 mm	LC	-015	
	-0.0020 mm	LC	-020	
	$\}$ (0.005 mm step) $\}$	$\}$ LC (005 step) $\}$		
	-0.600 mm	LC	-600	

- When the error characteristics of the machine are known, select the most suitable compensation amount from the table, and perform setting of addition or subtraction referring to "5-1-3. Setting the linear compensation."
- When the error characteristics of the machine are unknown, measure the error to be compensated according to the method described in 6-2. and select an appropriate compensation amount from the table. Set the selected amount according to "5-1-3. Setting the linear compensation."

6-2. Measuring Linear Compensation Amount

Note

The following applies when the resolution is 0.0005mm.

- 1 Place a block gauge ① on the machine table until the block gauge ① assumes the same temperature as the machine table. Then touch the surface B of the block gauge ① with a block gauge ②.

Example: $L = 250$ mm

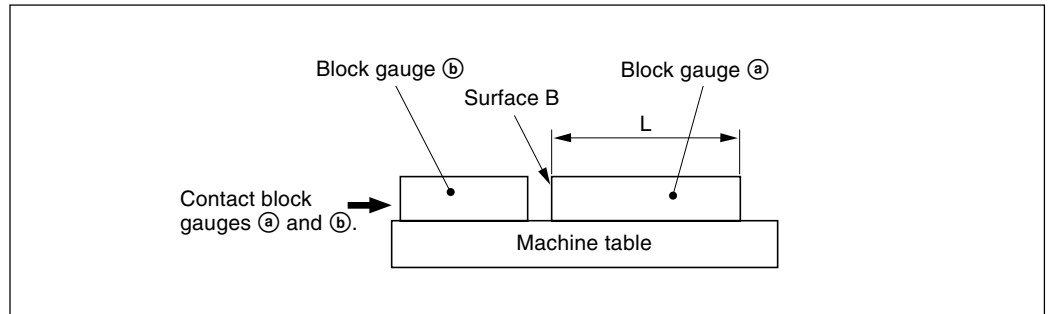

- 2 Touch the surface A of the block gauge ① with the probe of an electric micrometer or dial gauge and move the machine table until the meter of the micrometer or the dial gauge reads "0", where the datum point is obtained. Simultaneously reset the counter unit.

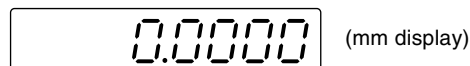

- 3 Press the RESET key at the same time when the meter reads "0".

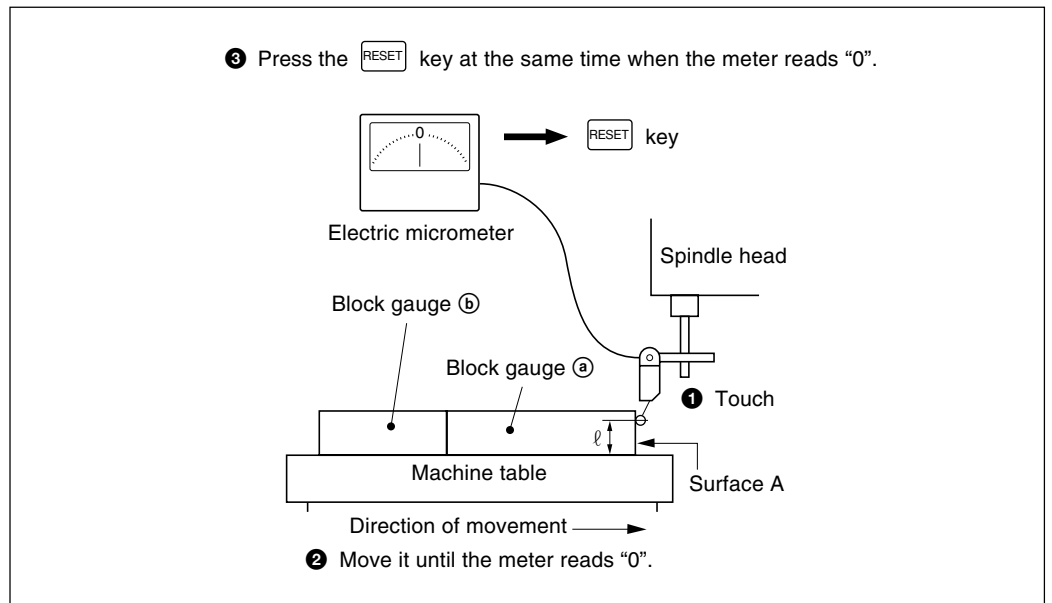

- 3** Next, move the table away from the probe and remove the block gauge (a), move the machine table again, touch the surface C of the block gauge (b) with the probe of the electric micrometer or dial gauge, and move the machine table until the meter reads "0". The difference between the length L of the block gauge (a) and the displayed value on the counter unit is the linear error to be compensated.

Examples of setting linear compensation amounts are shown on the next page.

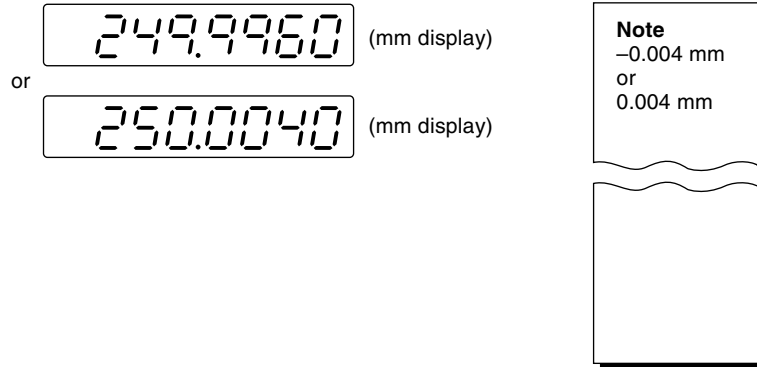

Be sure to write down the selected compensation amount.

Note

When measuring surfaces A and C with the probe, the heights of the probe must be the same. Otherwise, the measurement error may increase.

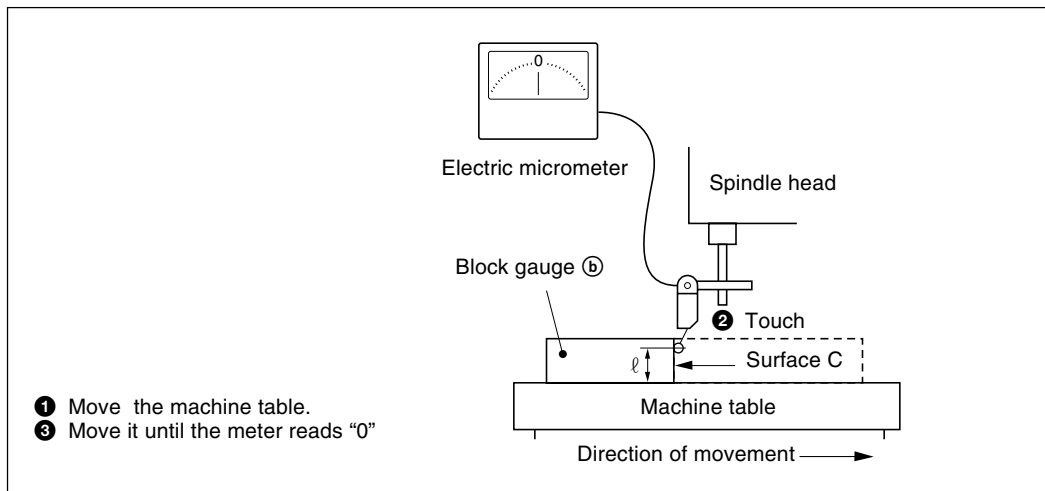

Examples of setting linear compensation amounts.

As the mechanical error is measured, set the compensation amount with reference to the following examples.

Addition or subtraction to or from the displayed value for the displacement
--

L: Length of block gauge ③
ℓ: Displayed value for the distance between the surfaces A and C

When $L > \ell$, add a compensation amount to the displayed value.

Set an appropriate positive compensation amount.

- Example in millimeter operation

Where $L = 250$ mm, $\ell = 249.9960$ mm, the difference between L and ℓ is 0.004 mm. The amount χ to be compensated per meter (1000 mm) is:

$$\frac{0.004 \text{ mm}}{250 \text{ mm}} \rightarrow \frac{\chi}{1000 \text{ mm}} \quad \chi = 0.016 \text{ mm}$$

The compensation amount, therefore, is 0.016 mm.

Set "015" as the closest compensation amount.

When $L < \ell$, subtract a compensation amount from the displayed value.

Set an appropriate negative compensation amount.

- Example in millimeter operation

Where $L=250$ mm, $\ell=250.0040$ mm, the difference between L and ℓ is 0.004 mm. The amount χ to be compensated per meter (1000 mm) is:

$$\frac{0.004 \text{ mm}}{250 \text{ mm}} \rightarrow \frac{\chi}{1000 \text{ mm}} \quad \chi = 0.016 \text{ mm}$$

Therefore the compensation amount is -0.016 mm.

Set "-015" as the closest compensation amount.

7. Remote Reset Input Connector

The display can be remote-reset to zero by connecting a mechanical or electronic (IC) switch to the remote reset input connector.
The input circuit of each axis is as shown below.

Pin numbers of remote reset input connector

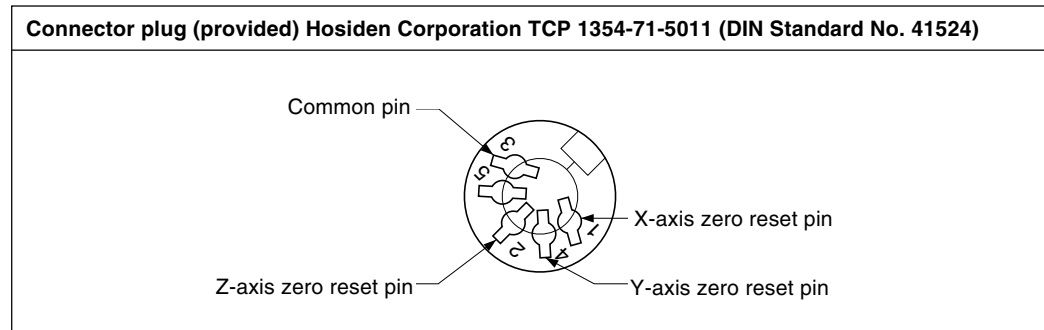

Interface Cable

The interface cable to be connected to the remote reset input connector must be shielded as follows.
(The cable length should be no more than 30 m.)

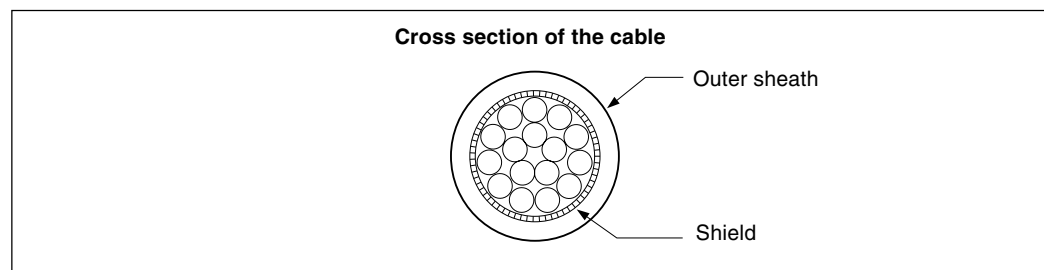

Remote reset input circuit

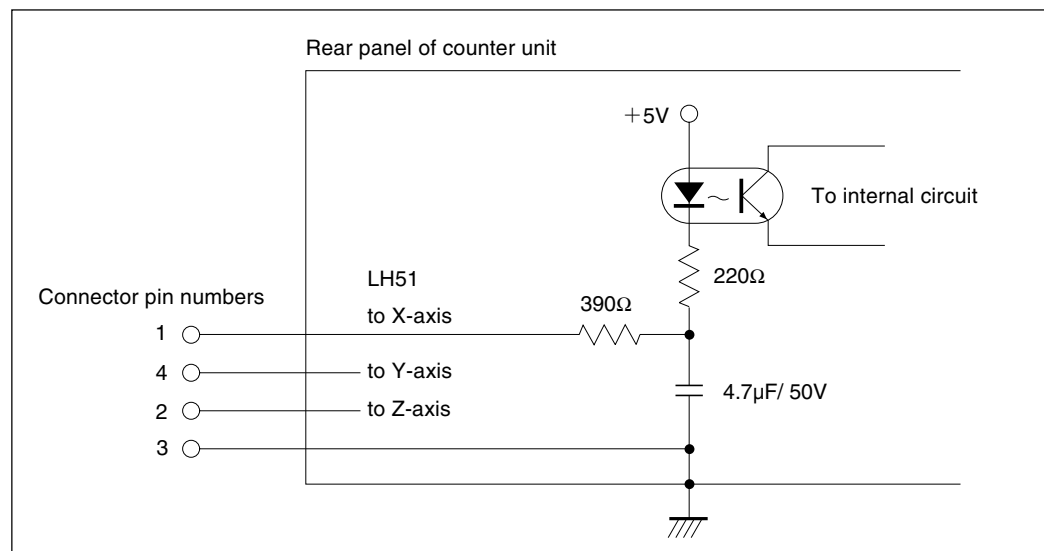

- When using the remote reset, connect the remote reset input terminal to the (GND) common terminal for at least 30 ms.
Before inputting the remote reset a second time, set the unit to OFF for at least 30ms.
- Use SN75451 or SN75452 for an electronic switch.
- Use a shielded cable for connection and connect the shield sheath to the shell of the supplied connector. The common pin should be wired separately from the shield sheath.
(Prepare a proper switch and a shielded cable by yourself.)

Assembly of the external reset input connector

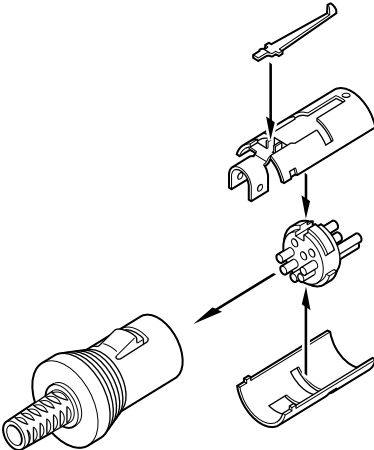























8. Alarm Display

When any one of the displays described below appears, reset and perform the operation from the beginning.

Display	Trouble	Causes
Error	Scale disconnected	When the scale is not connected: Turn the power off, connect the scale, and turn the power back on again. The display will be reset to "0".
	Excess speed	When the scale movement exceeds the maximum response speed of the counter unit. (This alarm also functions when the machine receives a great shock.)
F000000	Overflow	When the display overflows, "F" is indicated in the most significant digit.
SONY	Power failure	When the power fails momentarily during measurement.
Flashes SONY	Error in stored data	When the stored data has been changed by noise, etc.
-----	Energy-saving mode	When there are no key operations and the scale is not moved. (→This is canceled by pressing any key.)





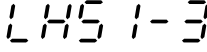
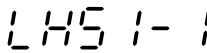
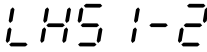

Note

When an error in the stored data is shown by "SONY" flashing on the display, all the data for that axis is cleared. In addition, the machine setting contents may also be cleared. In these cases, perform the following machine settings, and then make the settings again according to "5-1. Initial Settings" (page 11).







Operating procedure	Display
  <p>Turn on the power while holding down the X-axis  key and the 1/2 key.</p>  <p>Press the Preset key.</p> <p>When using the LH51-3</p>  <p>Press the  key.</p> <p>When using the LH51-1 or LH51-2</p>     <p>or</p>     <p>Press    or    keys and the Preset key.</p>  <p>Press the  key.</p>	 <p>All digits light up</p>   <p>or</p> 

9. Troubleshooting

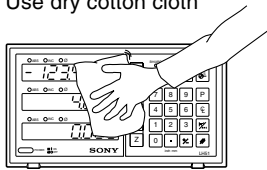
When the unit does not work properly, check the following before calling Sony Manufacturing Systems Corporation. Representative for service.

<p>The power cannot be turned on. (Unstable power connection)</p>		<ul style="list-style-type: none"> • Turn off the power switch and turn it on 1 to 2 minutes later. • Check the connection and continuity of the power cable. • Check for the proper range of power voltage.
<p>SONY is displayed. (Alarm)</p>		<ul style="list-style-type: none"> • Check the connection and continuity of the power cable. • Check for high level noises. (Replace with a normal axis.) • Turn off the power switch and turn it on 3 seconds later. • Perform resetting operation.
<p>Error is displayed. (Alarm)</p>		<ul style="list-style-type: none"> • Check the scale signal connector is secured by screws. • Check the conduit cable is not damaged or disconnected. • Check to see if the scale has moved faster than the maximum response speed. • Check for any severe vibration. • Check for high level noises. (Replace with a normal axis.) • Turn off the power switch and turn it on 3 seconds later. • Perform resetting operation.
<p>No counting</p>		<ul style="list-style-type: none"> • Turn off the power switch and turn it on 3 seconds later. • Check to see if the scale signal connector is loosely coupled. (Replace with a normal axis.)
<p>Erroneous counting</p>		<ul style="list-style-type: none"> • Turn off the power switch and turn it on 3 seconds later. • Check to see if the scale signal connector is loosely coupled. • Check for poor grounding due to rust or breakage. • Check the power voltage is in the specified range. (To keep power voltage within the specified range, use an automatic AC voltage regulator.) • Check that the grounding is made correctly.
<p>Accuracy cannot be obtained</p>		<ul style="list-style-type: none"> • Check to see if the unit occasionally miscounts. • Check for any mechanical trouble that may affect accuracy. (Any trouble due to machine adjustment, deflection or play). • Check to see if the temperature difference between the scale, machine and workpiece is great.

Cleaning

<p>To clean the display and casing:</p> <p>Use dry cotton cloth</p> 	<p>To remove heavy dirt:</p> <div style="display: flex; justify-content: space-between;"> <div style="text-align: center;">  <p>Use diluted neutral detergent</p>  </div> <div style="text-align: center;">  <p>Do not use</p> <div style="display: flex; justify-content: space-around; margin-top: 10px;"> <div style="text-align: center;">  <p>alcohol</p> </div> <div style="text-align: center;">  <p>thinner</p> </div> <div style="text-align: center;">  <p>benzine</p> </div> </div> </div> </div>	
--	--	--

10. Specifications

Model	LH51-2T02	LH51-3T07
Item		
No. of axes displayed	2 axes	3 axes
Display digits	Mode display and signed 7-digit display (leading-zero suppress, floating minus sign system)	
Resolution	<ul style="list-style-type: none"> • Magnescale axes : 0.0005 mm, 0.001 mm, 0.005 mm, 0.01 mm and diameter display (0.00002", 0.00005", 0.0001", 0.0005" and diameter display) • GA axes : 0.005 mm, 0.01 mm and diameter display (0.0002", 0.0005", 0.001" and diameter display) • Digiruler axes : 0.01 mm, 0.02 mm, 0.05 mm, 0.1 mm and diameter display (0.0005", 0.001", 0.002", 0.005" and diameter display) 	
Maximum response speed	<ul style="list-style-type: none"> • Magnescale axes : 60 m/min. (39"/s) (however, 1.8 m/min. during absolute zero point detection) • GA axes : 60 m/min. (39"/s) • Digiruler axes : 300 m/min. (196"/s) 	
Alarm display	<ol style="list-style-type: none"> 1. Temporary power failure 2. Scale disconnected or scale movement speed faster than the maximum response speed 3. Error in stored data 	
Reset	Resettable with key switch control or external reset.	
Preset	Preset with key switch control.	
Recall	Recall of the data stored by Preset with key switch control.	
Datum point memory	Datum point can be set with key switch control.	
ABS/INC conversion	With the datum point set at any point on the scale, the absolute distance from the datum point can be displayed while machining in the INC mode.	
Halving	When the INC mode display is selected, the displayed value can be halved with key and switch operations.	
Bolt hole circle	The cutting point (division point) coordinates can be displayed around the edge of a circle centering on the desired position by entering the diameter and number of divisions. Angle calculations are performed in 0.001° units. However, 0.001° units are calculated by linear interpolation using the 0.01° unit values.	
Simple R cutting	The cutting point coordinates for simple R cutting can be displayed by entering the radius R, tool bore and feed angle.	
Absolute zero point detection/Offset absolute zero point	Combined with a scale with an absolute zero point, the datum point can be relocated by detecting the absolute zero point.	
Touch sensor	Combined with the touch sensor (option), the datum plane can be detected, etc. <ol style="list-style-type: none"> 1. Hold function 2. Load function 3. Centering function 	
Data storage	The value displayed before the power was turned off and the preset data are stored. (uses nonvolatile memory)	
Machine error compensation	When the table moves a certain distance, a unit of compensation value is added or subtracted for linear compensation. 256 different compensation amounts are available. Compensation amount: Max. ±600 μm/m (±0.0006 inch/inch)	
In/mm conversion	The displayed value is converted between inch and millimeter with a switch.	
Power voltage	~100 to 230 V ±10% (50/60 Hz)	
Power consumption	Max. 35 VA	
Operating environment	<ul style="list-style-type: none"> • Operating guaranteed temperature and humidity range: 0 to 40°C (32 to 104°F), 20 to 90% RH (no condensation) *See the Note on the next page. • Storage temperature and humidity range: -20 to 60°C (-4 to 140°F), 20 to 90%RH (no condensation) • Operating guaranteed pressure : 860 to 1060 hPa • Installation categories : II • Pollution degree : 2 	
Scaling function	Display magnification: 0.100000 to 9.999999	
Multiple datum point memory function	250 data sets, with the data for each axis considered as one set.	

Item \ Model	LH51-2T02	LH51-3T07
Outside dimensions	235 mm (W) × 80 mm (D) × 130 mm (H) / 9.25" × 3.15" × 5.12"	
Mass	Approx. 1.6 kg / 3.5 Lbs	
Accessories	Power cord 1 set Ground wire 1 pc. Remote reset connector 1 pc. Dust caps 2 pcs. ⊕ M4 × 16 screws 2 pcs. Instruction manual 1 set	

Note

The guaranteed operating range stipulated by the safety standards is shown below.

Guaranteed Operating Humidity Range Stipulated by the Safety Standards

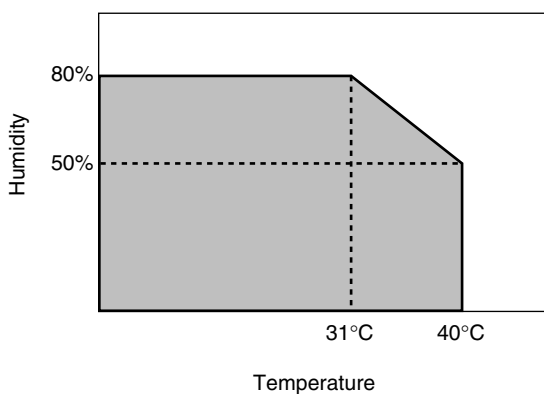

11. Dimensions

Specifications and appearances of the products are subject to change for improvement without prior notice.

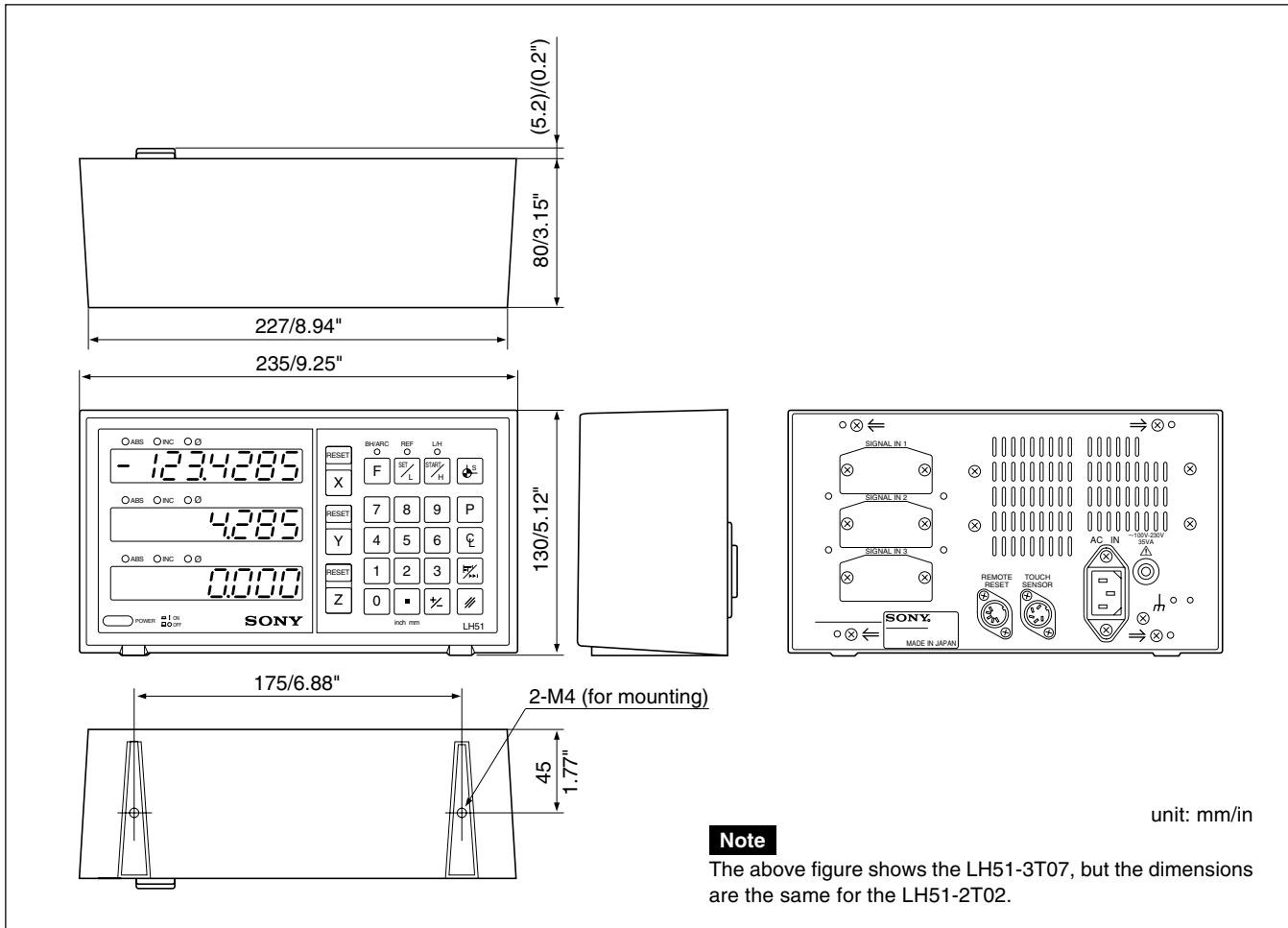

Note

The above figure shows the LH51-3T07, but the dimensions are the same for the LH51-2T02.

unit: mm/in

このマニュアルに記載されている事柄の著作権は当社にあり、説明内容は機器購入者の使用を目的としています。したがって、当社の許可なしに無断で複写したり、説明内容（操作、保守など）と異なる目的で本マニュアルを使用することを禁止します。

The material contained in this manual consists of information that is the property of Sony Manufacturing Systems Corporation and is intended solely for use by the purchasers of the equipment described in this manual.

Sony Manufacturing Systems Corporation expressly prohibits the duplication of any portion of this manual or the use thereof for any purpose other than the operation or maintenance of the equipment described in this manual without the express written permission of Sony Manufacturing Systems Corporation.

Le matériel contenu dans ce manuel consiste en informations qui sont la propriété de Sony Manufacturing Systems Corporation et sont destinées exclusivement à l'usage des acquéreurs de l'équipement décrit dans ce manuel.

Sony Manufacturing Systems Corporation interdit formellement la copie de quelque partie que ce soit de ce manuel ou son emploi pour tout autre but que des opérations ou entretiens de l'équipement à moins d'une permission écrite de Sony Manufacturing Systems Corporation.

Die in dieser Anleitung enthaltenen Informationen sind Eigentum von Sony Manufacturing Systems Corporation und sind ausschließlich für den Gebrauch durch den Käufer der in dieser Anleitung beschriebenen Ausrüstung bestimmt.

Sony Manufacturing Systems Corporation untersagt ausdrücklich die Vervielfältigung jeglicher Teile dieser Anleitung oder den Gebrauch derselben für irgendeinen anderen Zweck als die Bedienung oder Wartung der in dieser Anleitung beschriebenen Ausrüstung ohne ausdrückliche schriftliche Erlaubnis von Sony Manufacturing Systems Corporation.

Sony Manufacturing Systems Corporation
1-10 Kiyoku-cho, Kuki-shi, Saitama 346-0035 Japan

<http://www.sonysms.co.jp/>

LH51-2T02 / -3T07
2-917-548-13

2005.12
Printed in Japan
©2002 Sony Manufacturing Systems Corporation